

Gran Baristo Avanti

USER MANUAL

Type HD8967 / HD8968 / HD8969

Read carefully before using the machine.



App available on
Google Play starting
from October 2014

Tablet not included



CE 0051

Register your product and get support at
www.saeco.com/welcome



Saeco Avanti App

Available on the
App Store
Saeco Avanti App

GET IT ON
Google play
Saeco Avanti App

Avanti App is compatible with iPad 3/4/Air/mini retina, running iOS7 and newer; with Samsung Galaxy Tab 3 (8.0")/Tab 4 (10.1")/Note pro LTE (12.2"), Nexus 7 2013 (7"), Sony Xperia Z LTE (10.1"), running Android v.4.3 and newer, and Bluetooth version 4.0 and newer.

IMPORTANT SAFEGUARDS

When using electrical appliances, basic safety precautions should always be followed, including the following:

1. Read all instructions.
2. Do not touch hot surfaces. Use handles or knobs.
3. To protect against fire, electric shock and injury to persons do not immerse cord, plugs, or appliance in water or other liquid.
4. Close supervision is necessary when the appliance is used by or near children.
5. Unplug from outlet when not in use and before cleaning. Allow to cool before putting on or taking off parts, and before cleaning the appliance.
6. Do not operate any appliance with a damaged cord or plug or after the appliance malfunctions, or has been damaged in any manner. Return appliance to the nearest authorized service facility for examination, repair or adjustment.
7. The use of accessory attachments not recommended by the appliance manufacturer may result in fire, electric shock or injury to persons.
8. Do not use outdoors.
9. Do not let cord hang over edge of table or counter, or touch hot surfaces.
10. Do not place on or near a hot gas or electric burner, or in a heated oven.
11. Always attach plug to appliance first, then plug cord into wall outlet. To disconnect, turn any control to "off", then remove plug from wall outlet.
12. Do not use appliance for other than intended use.
13. Save these instructions.

SAVE THESE INSTRUCTIONS

CAUTION

This appliance is for household use only. Any servicing, other than cleaning and user maintenance, should be performed by an authorized service center. Do not immerse machine in water. To reduce the risk of fire or electric shock, do not disassemble the machine. There are no parts inside the machine serviceable by the user. Repair should be done by authorized service personnel only.

1. Check voltage to be sure that the voltage indicated on the nameplate corresponds with your voltage.
2. Never use warm or hot water to fill the water tank. Use cold water only.
3. Keep your hands and the cord away from hot parts of the appliance during operation.
4. Never clean with scrubbing powders or harsh cleaners. Simply use a soft cloth dampened with water.
5. For optimal taste of your coffee, use purified or bottled water. Periodic descaling is still recommended every 2-3 months.
6. Do not use caramelized or flavored coffee beans.

INSTRUCTIONS FOR THE POWER SUPPLY CORD

- A. A short power-supply cord (or detachable power-supply cord) is to be provided to reduce risks resulting from becoming entangled in or tripping over a longer cord.
- B. Longer detachable power-supply cords or extension cords are available and may be used if care is exercised in their use.
- C. If a long detachable power-supply cord or extension cord is used,
 1. The marked electrical rating of the detachable power-supply cord or extension cord should be at least as great as the electrical rating of the appliance
 2. If the appliance is of the grounded type, the extension cord should be a grounding-type 3-wire cord, and
 3. The longer cord should be arranged so that it will not drape over the counter top or table top where it can be pulled on by children or tripped over.

Congratulations on your purchase of a Saeco GranBaristo Avanti fully automatic coffee machine!

To fully benefit from the support that Saeco offers, please register your product at www.saeco.com/welcome.

This user manual applies to HD8967 / HD8968 / HD8969 models.

The machine is suitable for preparing espresso coffee using whole coffee beans, and it is supplied with a milk carafe to prepare a perfect Cappuccino or Latte Macchiato in a quick and easy way. In this user manual you will find all the information you need to install, use, clean and descale your machine.

Visit www.philips.com/support to download the latest version of the user manual and the EC declaration of conformity (see product code on the cover).

CONTENTS

IMPORTANT	4
Safety Instructions	4
Warnings.....	4
Cautions.....	6
Compliance with Standards	8
INSTALLATION	10
Product Overview.....	10
General Description.....	11
PREPARING FOR USE	12
Machine Packaging.....	12
Machine Installation	12
USING THE MACHINE FOR THE FIRST TIME	15
Language Selection.....	15
Automatic Rinse/Cleaning Cycle	16
Manual Rinse Cycle.....	17
Measuring and Programming Water Hardness	20
"INTENZA+" Water Filter Installation	22
Replacing the "INTENZA+" Water Filter	25
BLUETOOTH CONNECTION	26
CHANGING COFFEE BEANS	29
Removing the Coffee Bean Hopper.....	29
Inserting the Coffee Bean Hopper	30
Coffee Emptying Cycle.....	31
Profile Selection	34
ADJUSTMENTS	35
Coffee Profile.....	35
Enabling a New Profile.....	35
Disabling a User Profile	36
Saeco Adapting System.....	38
Adjusting the Ceramic Coffee Grinder	38
Adjusting the Aroma (Coffee Strength)	39
Adjusting the Dispensing Spout	40
Adjusting the Coffee Quantity	42
BREWING COFFEE	43
Coffee Brewing Using Coffee Beans	43
Coffee Brewing Using Pre-Ground Coffee	44
MILK CARAFE	46
Filling the Milk Carafe	46

Inserting the Milk Carafe	47
Removing the Milk Carafe	47
Emptying the Milk Carafe	48
BREWING MILK-BASED BEVERAGES	49
Quick Carafe AUTO CLEAN Cycle	52
Adjusting the Milk-Based Product Length	53
SPECIAL BEVERAGES	55
Hot Water	55
Adjusting Hot Water Dispensing	57
Special Beverages Menu for Brewing Other Beverages	58
Adjusting the Other Beverages Quantity for the “Special Beverages” Menu	59
BEVERAGE PROGRAMMING	60
Aroma	61
Coffee Quantity	61
Temperature	61
Taste	62
Milk Quantity	62
HOT WATER PROGRAMMING	62
Water Quantity	62
Temperature	63
RESTORING BEVERAGE PARAMETERS	63
MACHINE PROGRAMMING	64
Water settings	64
Language Settings	65
Stand-by Settings	65
Button Sound	66
Bluetooth	66
Factory Settings	67
STATISTICS	67
MAINTENANCE	68
Descaling	68
Brew Group Cleaning Cycle	68
Cleaning of the Carafe	69
Coffee Circuit Cleaning	69
CLEANING AND MAINTENANCE	70
Daily Cleaning of the Machine	70
Daily Cleaning of the Water Tank	72
Daily Cleaning of the Milk Carafe	72
Weekly Cleaning of the Milk Carafe	75
Weekly Cleaning of the Brew Group	79
Weekly Cleaning of the Coffee Bean Hopper, Tray and Coffee Compartment	83
Monthly Cleaning of the Milk Carafe	85
Monthly Lubrication of the Brew Group	89
Monthly Cleaning of the Brew Group with “Coffee Oil Remover”	90
DESCALING	93
ACCIDENTAL INTERRUPTION OF THE DESCALING CYCLE	98
DISPLAY MESSAGES	99
TROUBLESHOOTING	101
ENERGY SAVING	104
Stand-by	104
Disposal	105
TECHNICAL SPECIFICATIONS	106
WARRANTY AND SERVICE	107
Warranty	107
Service	107
ORDERING MAINTENANCE PRODUCTS	108
MACHINE ACCESSORIES	109

IMPORTANT

Safety Instructions

This machine is equipped with safety devices. Nevertheless, read and follow the safety instructions carefully and only use the machine properly as described in these instructions to avoid accidental injury or damage due to improper use of the machine.

Keep this user manual for future reference.



The term **WARNING** and this icon warn against possible severe injuries, danger to life and/or damage to the machine.



The term **CAUTION** and this icon warn against slight injuries and/or damage to the machine.



This icon requests you to read carefully this instruction manual, before any use or maintenance operation.

Warnings

- In case of using the machine remotely connected via mobile application, the user must make sure that:
 - The machine has been correctly installed;
 - The machine is only operated from a short distance (i.e. in the user's line of sight);
 - There are no vulnerable persons / children near the machine during operation.
- Connect the machine to a wall socket with a voltage matching the technical specifications of the machine.
- Connect the machine to a earthed wall socket.

- Do not let the power cord hang over the edge of a table or counter, or touch hot surfaces.
- Never immerse the machine, the mains plug or power cord in water: Danger of electrical shock!
- Do not pour liquids on the power cord connector.
- Never direct the hot water jet towards body parts: Danger of burning!
- Do not touch hot surfaces. Use handles and knobs.
- Remove the mains plug from the wall socket:
 - if a malfunction occurs;
 - If the machine will not be used for a long time;
 - before cleaning the machine.

Pull on the mains plug, not on the power cord. Do not touch the mains plug with wet hands.

- Do not use the machine if the mains plug, the power cord or the machine itself is damaged.
- Do not make any modifications to the machine or its power cord. Only have repairs carried out by a service centre authorised by Philips to avoid any hazard.
- The machine should not be used by children younger than 8 years old.
- The machine can be used by children of 8 years and upwards if they have previously been instructed on the correct use of the machine and made aware of the associated dangers or if they are supervised by an adult.
- Cleaning and maintenance should not be carried out by children unless they are more than 8 years old and supervised by an adult.

- Keep the machine and its power cord out of reach of children under 8 years old.
- The machine may be used by persons with reduced physical, sensory or mental capabilities or lacking sufficient experience and/or skills if they have previously been instructed on the correct use of the machine and made aware of the associated dangers or if they are supervised by an adult.
- Children should be supervised to ensure that they do not play with the machine.
- Never insert fingers or other objects into the coffee grinder.

Cautions

- The machine is for household use only. It is not intended for use in environments such as canteens, staff kitchens of shops, offices, farms or other work environments.
- Always put the machine on a flat and stable surface.
- Do not place the machine on hot surfaces, directly next to a hot oven, heater units or similar sources of heat.
- Only put roasted coffee beans into the coffee bean hopper. If ground coffee, instant coffee, raw coffee or any other substance is put in the coffee bean hopper, it may damage the machine.
- Let the machine cool down before inserting or removing any parts.

- Never use warm or hot water to fill the water tank. Use only cold non-sparkling drinking water.
- Never clean with scrubbing powders or harsh cleaners. Simply use a soft cloth dampened with water.
- Descale your machine regularly. The machine indicates when descaling is needed. Not doing this will make your appliance stop working properly. In this case repair is not covered under your warranty!
- Do not keep the machine at temperature below 0 °C. Residue water in the heating system may freeze and cause damage.
- Do not leave water in the water tank if the machine is not used over a long period of time. The water can get contaminated. Use fresh water every time you use the machine.
- Keep in mind that this is a connected device with a potential risk of being accessed by unauthorised people. If you detect any inexplicable behaviours, please contact the Philips service centre.
- Carefully place the machine in your household in order not to reduce its field of action when operating it via the App (away from routers, microwave ovens, docking stations, etc.).

Compliance with Standards

The machine complies with art.13 of the Italian Legislative Decree dated 25 July 2005, no. 151 "Implementation of the Directives 2005/95/EC, 2002/96/EC and 2003/108/EC on the restriction of the use of certain hazardous substances in electrical and electronic equipment, as well as waste disposal".

This machine complies with EU Directive 2002/96/EC.

This Philips appliance complies with all the applicable standards and regulations relating to the exposure to electromagnetic fields.

Philips Consumer Lifestyle B.V.

PHILIPS

426

2014/07

*(Document No.)**(Year, Month (yyyy/mm) in which the CE mark is affixed)***EUROPEAN DECLARATION OF CONFORMITY**

We, PHILIPS CONSUMER LIFESTYLE B.V.

(Company name)

TUSSENDIEPEN 4, 9206 AD DRACHTEN, THE NETHERLANDS

(address)

declare under our responsibility that the product(s): HD8969, HD8968, HD8967

Philips

*(brand name)**(Type version or model)*

ESPRESSO COFFEE MAKER WITH GRINDER

(product description)

to which this declaration relates is in conformity with the following harmonized standards:

EN 60335-1: (2012)
 EN 60335-2-15:(2002), Am1 (2005), Am2 (2008), A11 (2012)
 EN 62233: (2008)
 EN 55014-1: (2006), Am1 (2009), Am2 (2011)
 EN 61000-3-2: (2006), Am1 (2009), Am2 (2009), EN 61000-3-3: (2008)
 EN 55014-2: (1997), Am1 (2001), Am2 (2008)
 EN 50564: (2011), EN 50581: (2012)
 EN 300 328: (2012) V1.8.1 & V1.7.1, EN 301 489-1: (2011) V1.9.2
 EN 301 489-17: (2012) V2.2.1, EN 62479: (2010)

following the provisions of :

2006/95/EC
 2004/108/EC
 2009/125/EC, EC/1275/2008
 2011/65/EC
 1999/5/EC

And are produced under a quality scheme at least in conformity with ISO 9001 or CENELEC Permanent Documents

Only for Medical Devices and R&TTE products:

The Notified Body: IMQ 0051
(Name and number)

performed: EMC R&TTE

and issued the certificate: 0532-ARSO00045
(certificate number)

Remarks:



Drachten, 17-jun-14

(place, date)

A. Speelman, CL Compliance Manager

(signature, name and function)

INSTALLATION

Product Overview

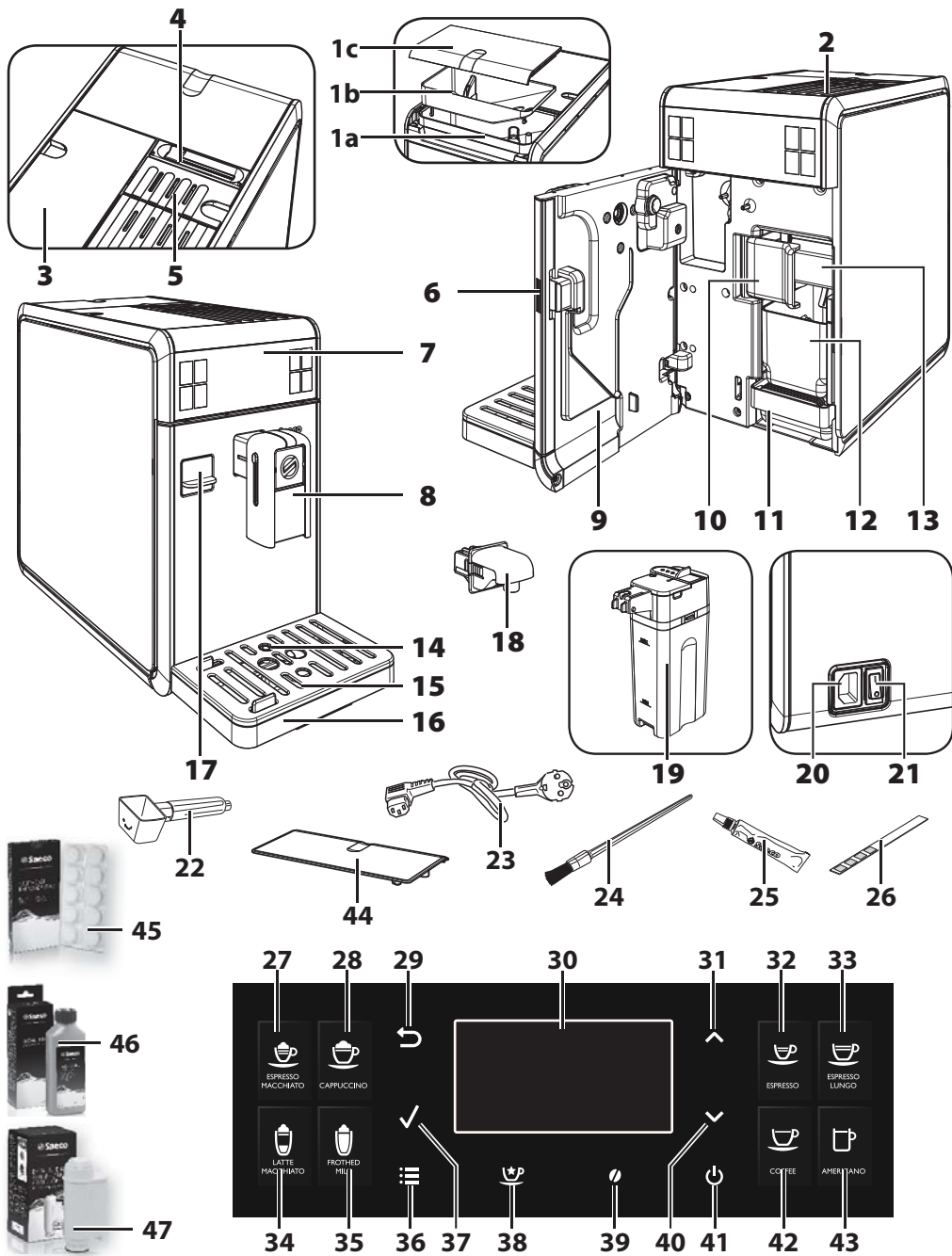

General Description

- 1a. Coffee bean hopper
- 1b. Coffee bean hopper tray
- 1c. Coffee bean hopper lid
2. Cup-warming surface
3. Water tank + lid
4. Coffee bean hopper locking/removal selector switch
5. Pre-ground coffee compartment
6. Service door button
7. Control panel
8. Removable coffee dispensing spout
9. Service door
10. Brew group locking/removal handle
11. Drip tray (internal)
12. Coffee grounds drawer
13. Brew group
14. Full drip tray indicator
15. Cup holder grill
16. Drip tray (external)
17. Protection lid
18. Water dispensing spout (removable)
19. Milk carafe
20. Power cord socket
21. Power button
22. Pre-ground coffee measuring scoop / grinder adjustment key.
23. Power cord
24. Cleaning brush (optional)
25. Grease for brew group (optional)
26. Water hardness test strip
27. Espresso Macchiato button
28. Cappuccino button
29. "ESC" button
30. LCD Display
31. "UP" button
32. Espresso button
33. Long Espresso button
34. Latte Macchiato button
35. Hot Milk button
36. "MENU" button
37. "OK" button
38. "Special beverages" button
39. "Aroma" - Pre-ground coffee button
40. "DOWN" button
41. Stand-by button
42. Coffee button
43. American Coffee button
44. Protection cover (optional)
45. Coffee oil remover (optional)
46. Descaling solution (optional)
47. "INTENZA+" Water filter (optional)

PREPARING FOR USE

Machine Packaging

The original packaging has been designed and constructed to protect the machine during transport. We recommend keeping the packaging material for possible future transport.

Machine Installation

1 Remove the drip tray with grill and the carafe from the packaging.

2 Remove the machine from the packaging.

3 For best use, it is recommended to:

- Choose a safe, level surface where there will be no danger of overturning the machine or being injured.
- Choose a location that is sufficiently well-lit, clean and near an easily reachable socket.
- Allow for a minimum distance from the sides of the machine as shown in the figure.

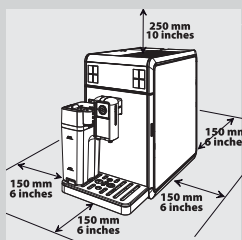

4 Insert the drip tray (external) with grill all the way into the machine. Make sure that it is correctly placed; a "CLICK" will confirm that it is locked into place.



Note:

The drip tray collects the water that comes out of the dispensing spout during each rinse/self-cleaning cycle, as well as any coffee that might be spilled during beverage brewing. Empty and wash the drip tray daily and each time the full drip tray indicator is raised.



Caution:

NEVER remove the drip tray when the machine has just been turned on. Wait a couple of minutes for the machine to carry out a rinse/self-cleaning cycle.

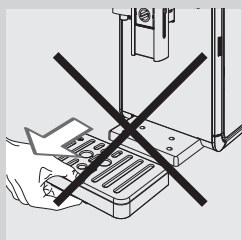

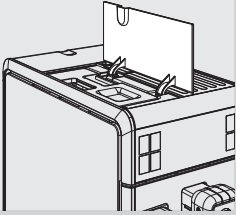

5 Lift the left outer lid.

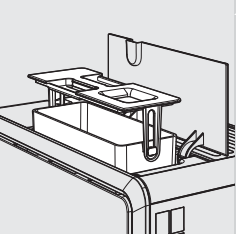

6 Remove the water tank by using the handle incorporated on the inner lid.

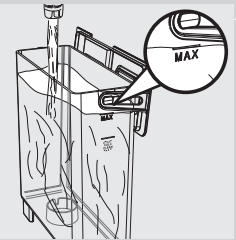

7 Rinse the water tank with fresh water.

8 Fill the water tank with fresh drinking water up to the MAX level and put it back into the machine. Make sure it is fully inserted.



Caution:

Never fill the water tank with warm, hot, sparkling water or any other liquid, as this may cause damage to the water tank and the machine.

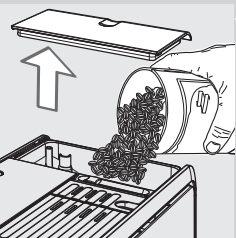

9 Remove the coffee bean hopper lid. Slowly pour in the coffee beans.



Note:

The coffee bean hopper contains a tray that vibrates during grinding and conveys the beans into the coffee grinder.



Caution:

Only coffee beans must be put into the coffee bean hopper. Ground coffee, instant coffee, caramelized coffee or any other object may damage the machine.

10 Put the lid back on the coffee bean hopper.

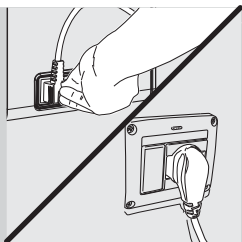

11 Insert the plug into the socket located on the back of the machine.

12 Insert the plug on the other end of the power cord into a wall socket with suitable power voltage.

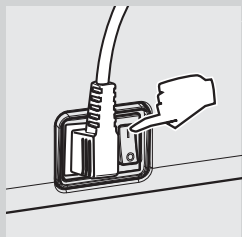

13 Switch the power button on the back of the machine to “I” to turn on the machine.



14 Press the  button to turn on the machine.

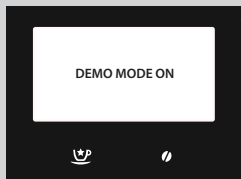

Note:

By keeping the  button pressed for more than 8 seconds, the machine enters the demo mode. To exit the demo, disconnect the power cord and turn the machine back on.

USING THE MACHINE FOR THE FIRST TIME

When using the machine for the first time, the following activities need to happen:

- 1) You have to select the language.
- 2) The machine will perform an automatic rinse/cleaning cycle.
- 3) You need to perform a manual rinse cycle.

Language Selection

At first start up, the language must be selected.

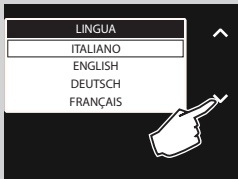

- 1 The following display is shown. Select the desired language by pressing the "▼" or "▲" scrolling button.



- 2 Press the "✓" button to confirm.

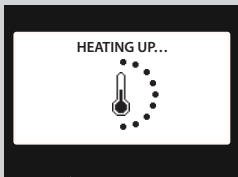

- 3 The machine is in warm-up phase.

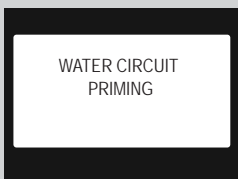

- 4 Once warm-up has been completed, the machine automatically performs the water circuit priming.

Automatic Rinse/Cleaning Cycle

When warm-up has been completed, the machine automatically performs a rinse/self-cleaning cycle of the internal circuit with fresh water. This takes less than a minute.

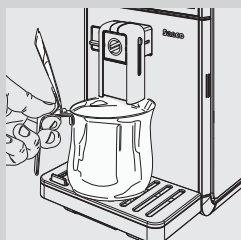

- 1 Place a container under the coffee dispensing spout to catch the small amount of water which will be dispensed.



- 2 The following display is shown. Wait for the cycle to finish automatically.



Note:

To stop dispensing, press the "↶" button.

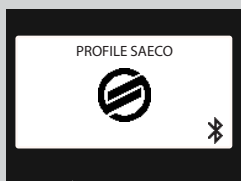

- 3 When the operations described above have been completed, the machine shows the following display. You can now perform the manual rinse cycle.

Manual Rinse Cycle

You need to perform a rinse cycle when using the machine for the first time. During this process, the coffee brewing cycle is activated and fresh water flows through the dispensing spout. This takes a few minutes.

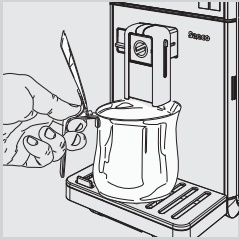

- 1 Place a container under the coffee dispensing spout.

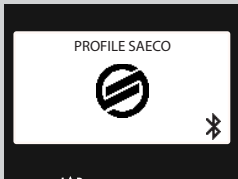

- 2 Check that the machine shows the following display.



- 3 Press the "☉" button to access the aroma selection menu.

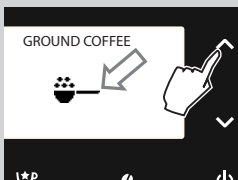

- 4 To select the pre-ground coffee brewing function, press the "▼" or "▲" scrolling button until the "☉" icon is displayed.



Note:

Do not add pre-ground coffee into the compartment.

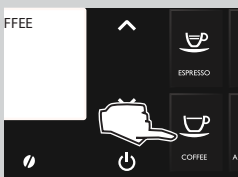

- 5 Press the "☉" button.



- 6 When choosing the product, the machine asks you to confirm that the ground coffee has been inserted. Press the "✓" button. The machine will start dispensing water from the coffee dispensing spout. When dispensing has been completed, empty the container.

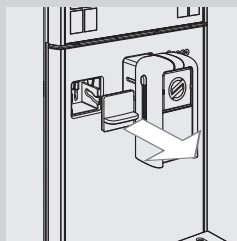

- 7 Remove the protection cover.

**Note:**

Store the cover with care.

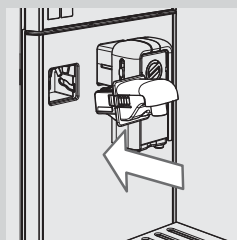

- 8 Slightly tilt the water dispensing spout and insert it all the way into the guides of the machine. Push the water dispensing spout towards the bottom while rotating it at the same time, until it is locked into the machine as shown in the figure.

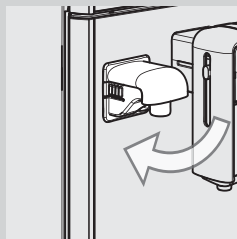

- 9 Place an empty container under the hot water dispensing spout.

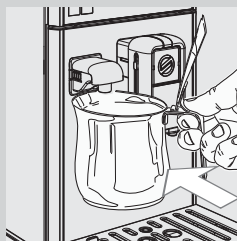

- 10 Press the "☺" button.





11 Press the “✓” button.

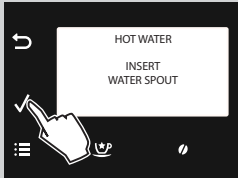

12 Press the “✓” button. At the end of the warm-up phase, the machine starts dispensing water.

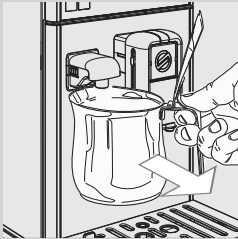

13 After dispensing water, remove and empty the container.

14 Repeat the operations from step 10 to 13 until the water tank is empty, then continue with step 15.

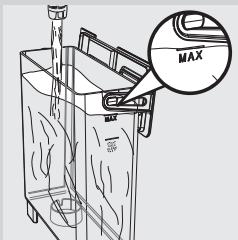

15 At the end, fill the water tank again up to the MAX level. Now the machine is ready to brew coffee. This icon will be displayed.

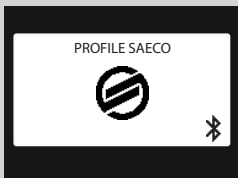

Note:

When you have not used the machine for 2 or more weeks, the machine will automatically perform an automatic rinse/self-cleaning cycle after you turn it on. Following this, you need to perform a manual rinse cycle as described above.

The automatic rinse/self-cleaning cycle also starts when the machine has been in stand-by mode, or turned off, for more than 15 minutes. At the end of the cycle, you can brew products.

Measuring and Programming Water Hardness

Water hardness measuring is very important in order to define the machine descaling frequency and to install the "INTENZA+" water filter (for more details on the water filter, see next chapter).

To measure the water hardness follow the steps below:

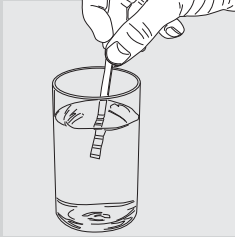

- 1 Immerse the water hardness test strip (supplied with the machine) in water for 1 second.



Note:

The test strip can only be used for one single measurement.

- 2 Wait for one minute.

- 3 Check how many squares have changed to red, then consult this table.



Note:

The numbers on the water hardness test strip correspond to the water hardness adjustment settings.

- More precisely:
- 1 = 1 (very soft water)
 - 2 = 2 (soft water)
 - 3 = 3 (hard water)
 - 4 = 4 (very hard water)

The letters correspond to the references that are located at the base of the "INTENZA+" water filter (see next chapter).

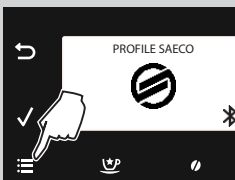
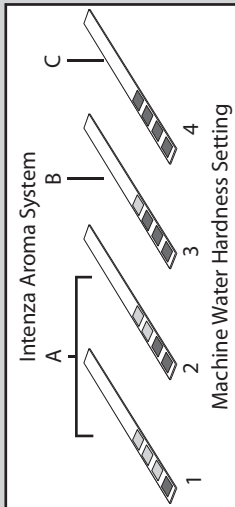

- 4 Press the "iii" button to access the machine main menu.

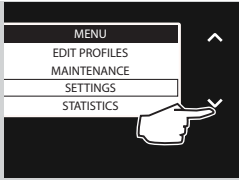

5 Press the “✓” button to select “**SETTINGS**”.

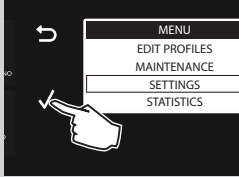

6 Press “✓” to confirm.

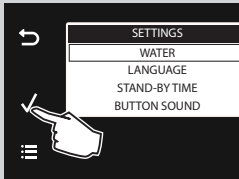

7 Press “✓” to confirm “**WATER**” selection.

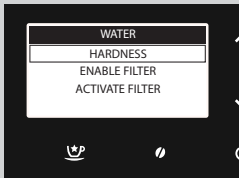

8 Press “✓” to confirm “**HARDNESS**” selection.



Note:

The machine is supplied with a standard water hardness setting, suitable for most types of water.

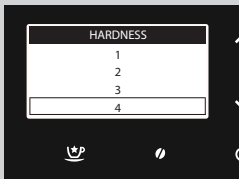

9 Press the “✓” button to increase the value or the “^” button to decrease the value.

10 Press the “✓” button to confirm the setting.

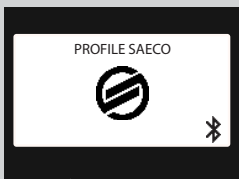

11 Press the “☰” button to exit the programming menu. Now the machine is ready for brewing.

“INTENZA+” Water Filter Installation



We recommend that you install the “INTENZA+” water filter as this prevents limescale build-up in your machine and preserves a more intense aroma of your coffee.

Water is a crucial part of every coffee, so it is very important to always have it professionally filtered. Using the “INTENZA+” water filter will prevent mineral deposits from building up and improve your water quality.

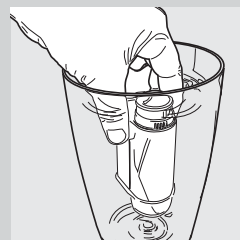

- 1 Remove the “INTENZA+” water filter from its packaging, immerse it vertically (with the opening positioned upwards) in cold water and gently press the sides so as to let the air bubbles out.

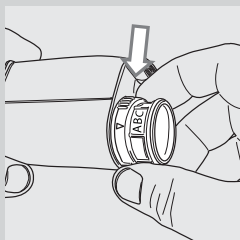

- 2 Set the “INTENZA+” water filter according to the measurements performed (see previous chapter) and indicated on the base of the filter:
 A = soft water – equals 1 or 2 on the test strip
 B = hard water (standard) – equals 3 on the test strip
 C = very hard water – equals 4 on the test strip

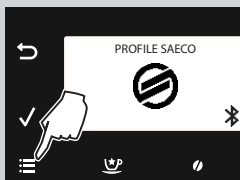

- 3 Press the “☰” button to access the machine main menu.

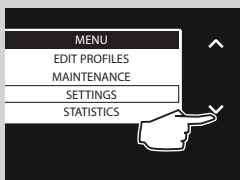

- 4 Press the “∨” button to select “SETTINGS”.

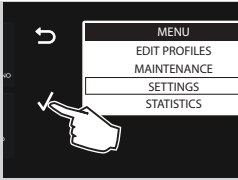

5 Press "✓" to confirm.

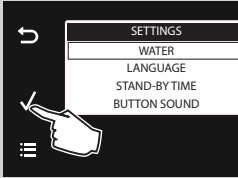

6 Press "✓" to confirm "WATER" selection.

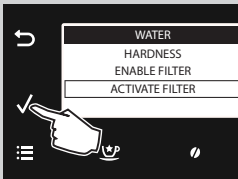

7 Press the "✓" button to select "ACTIVATE FILTER".

8 Press "✓" to confirm.

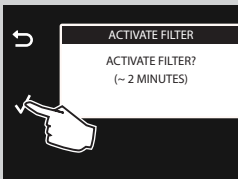

9 Press "✓" to confirm.



Note:

To exit activation, press the "↶" button.

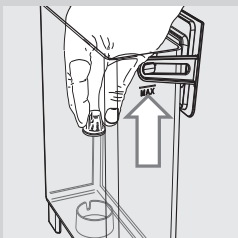

10 Remove the small white filter from the water tank and store it in a dry place.

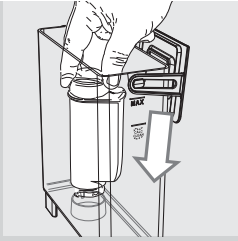

- 11 Put the "INTENZA+" water filter into the empty water tank. Press it down until it cannot move any further.
- 12 Fill the water tank with fresh water up to the MAX level and put it back into the machine.

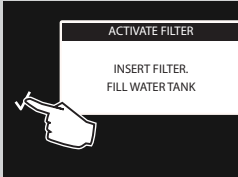

- 13 Press "✓" to confirm.

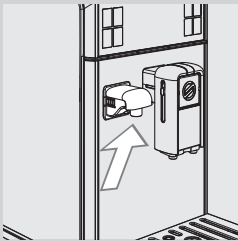

- 14 Check that the water dispensing spout is correctly installed.

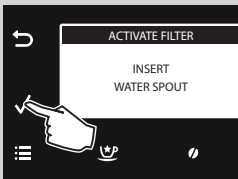

- 15 Press "✓" to confirm.

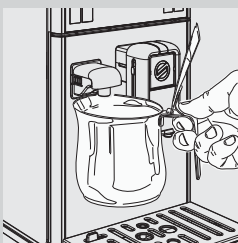

- 16 Place a container under the hot water dispensing spout.

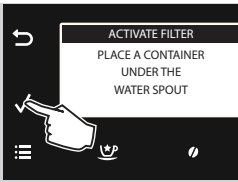

17 Press "✓" to confirm.

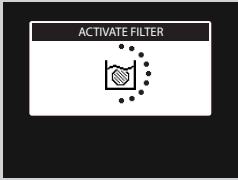

18 The machine starts dispensing water. This screen will be displayed.



19 When the machine stops dispensing, remove and empty the container. Now the machine is ready for brewing.

In this way the machine has been programmed to inform the user of the need to replace the "INTENZA+" water filter.

Replacing the "INTENZA+" Water Filter

When the "INTENZA+" water filter needs to be replaced with a new one, the following icon is displayed.

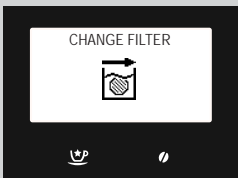

- 1** Replace the filter as described in the previous chapter.
- 2** The machine is now programmed to manage a new filter.

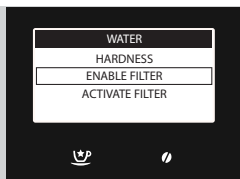
**Note:**

If the filter is already installed and you want to remove, but not replace it, select the **“ENABLE FILTER”** option and set it on OFF.

If there is no **“INTENZA+”** water filter installed, insert the small white filter previously removed into the water tank.

BLUETOOTH CONNECTION



Download the application on your mobile device to access the machine functions.

To connect GranBaristo Avanti with your mobile device, download the Saeco Avanti App available on the App Store and Google Play or scan the QR code on the cover with your mobile device. As an alternative, connect to the www.saeco.com/Avanti-app website using the device on which you wish to download the application.

**Note:**

Before starting the connection procedure, make sure that the Bluetooth function on your mobile device is active.

The GranBaristo Avanti Bluetooth function is enabled by default. If it is disabled, follow the instructions below to enable it again:

1 Press the **“☰”** button to access the machine main menu.

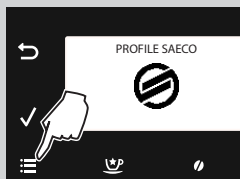

2 Press the **“✓”** button to select **“SETTINGS”**. Press **“✓”** to confirm.

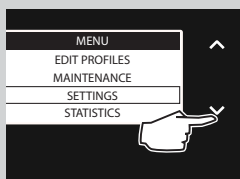

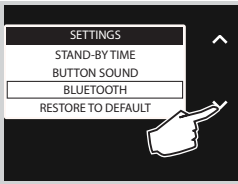

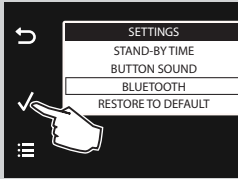

3 Press the “” button to select “**BLUETOOTH**”.

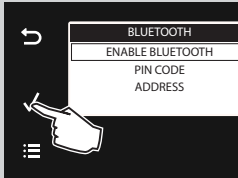

4 Press “” to confirm.



5 The “**BLUETOOTH**” management menu is displayed. Press “” to enable the function in the machine and to allow the connection of your mobile device.

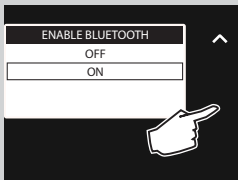

6 Press the “” button to select “**ON**”.

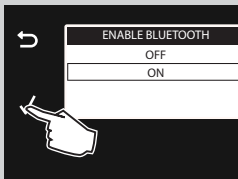

7 Press “” to confirm. The Bluetooth device is now active.

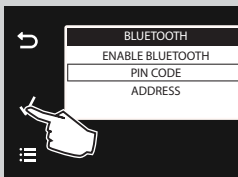

8 Press the “” button to select “**PIN CODE**”. Press “” to confirm.

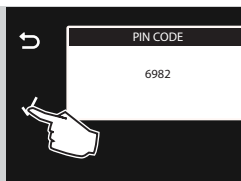

- 9 Write down the code, as it will be requested when connecting with your mobile device.

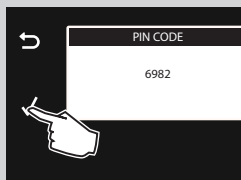

- 10 Press "✓" to confirm. Press the "☰" button to exit.



Note:

To exit the menu, press the "↶" button.

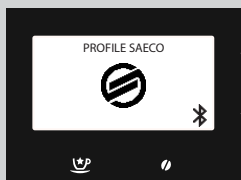

- 11 Enter the PIN code when you are prompted by the application and wait for a successful connection.

The  icon shown on the display indicates that the connection was successfully established. Now you can interact with your coffee machine directly from your mobile device.



Warning:

**Use the Saeco Avanti app to control your Gran Baristo only when you can see the machine in order to avoid injury or damage!
You cannot use the pre-ground coffee function when operating the machine via the app.**



Caution:

If you enter the wrong PIN code 5 times in a row, the machine disables the Bluetooth connection for safety reasons. Therefore, you will need to enable it again as previously explained.



Note:

Avanti App is compatible with iPad 3/4/Air/mini retina, running iOS7 and newer; with Samsung Galaxy Tab 3 (8.0")/Tab 4 (10.1")/Note pro LTE (12.2"), Nexus 7 2013 (7"), Sony Xperia Z LTE (10.1"), running Android v.4.3 and newer, and Bluetooth version 4.0 and newer.

CHANGING COFFEE BEANS

The machine comes with a removable coffee bean hopper so you can easily switch from one type of coffee bean to another and enjoy a different coffee taste.



Note:

You can buy an additional coffee bean hopper as an accessory (CA6807). To preserve their taste, you can store coffee beans in the bean hopper in the refrigerator.

Removing the Coffee Bean Hopper

To remove the coffee bean hopper follow the steps below:

- 1 Move the selector switch to the “☐” position.

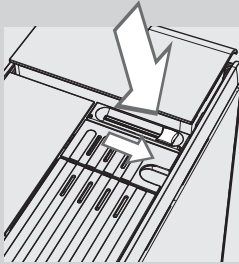

Caution:

It may happen that the selector switch cannot be moved to the desired position as it is blocked by coffee beans. In this case, move the selector switch back and forth repeatedly until the beans are released.

- 2 Lift the sides of the coffee bean hopper with both hands as shown in the image.

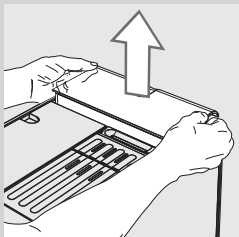

Caution:

Do not remove the coffee bean hopper in a different way to avoid spilling coffee beans.

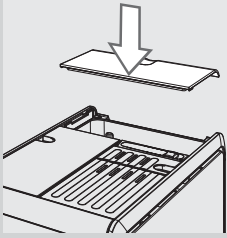

- 3 After removing it, put the protection lid on the machine.

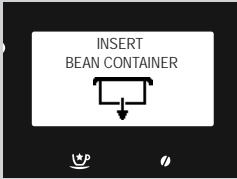
**Note:**

If a coffee product is requested without the coffee bean hopper inserted, the following icon will appear. You need to insert the coffee bean hopper first.

Inserting the Coffee Bean Hopper

To insert the coffee bean hopper follow the steps below:

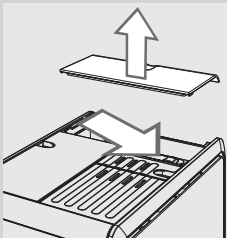

- 1 Remove the protection cover from the machine.
- 2 Move the selector switch to the "☐" position.

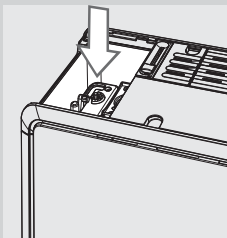

- 3 Remove any beans from the coffee bean hopper compartment.

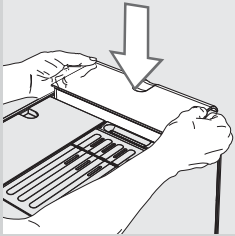

- 4 Insert the coffee bean hopper into its compartment as shown on the figure.

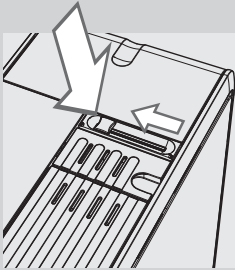

- 5 Move the selector switch to the "🔒" position.



Warning:

Please be aware that when you change coffee beans and switch to decaffeinated coffee, some caffeine traces might still be present even after performing an emptying cycle.

Coffee Emptying Cycle

When you switch from a type of coffee beans to another changing the coffee bean hopper, it is recommended to clean the coffee duct, in order to fully taste the new blend aroma. For this, follow the steps below:

- 1 Fill the coffee bean hopper or replace it with a new hopper.

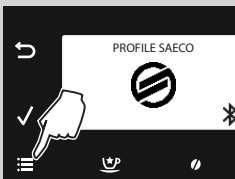

- 2 Press the "☰" button to access the machine main menu.

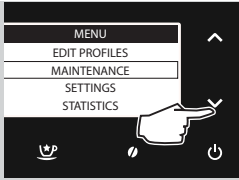

3 Press the "✓" button to select "**MAINTENANCE**".

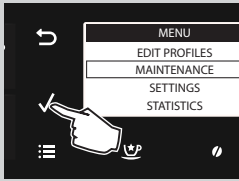

4 Press "✓" to confirm.

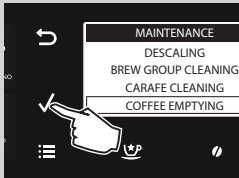

5 Press the "✓" button to select "**COFFEE EMPTYING**".

6 Press "✓" to confirm.



7 Press "✓" to confirm.



8 The machine performs a grinding cycle without brewing coffee.



9 Now the machine is ready for brewing.



Note:

If you have not emptied the coffee duct and grinder, you need to brew at least two coffees before you can taste the new coffee beans.



Warning:

Please be aware that when you change coffee beans and switch to decaffeinated coffee, some caffeine traces might still be present even after performing a cleaning cycle.

Profile Selection

This function allows you to optimize products brewing according to the coffee blend just inserted into the machine or personal preferences.

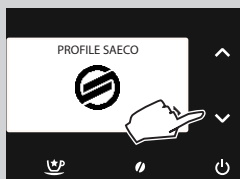

- 1 Press the “▼” button or the “▲” button to select the profiles saved in the machine.

You can choose between 3 coffee profiles, optimized according to the beans used:

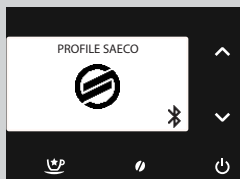

- The SAECO Blend profile, optimized for an Arabica and Robusta blend.

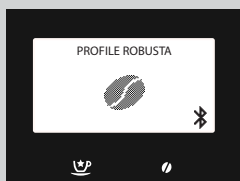

- The Robusta profile, optimized for Robusta coffee beans.

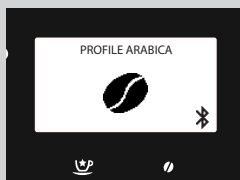

- The Arabica profile, optimized for Arabica coffee beans.



Note:

The machine also allows you to create 3 additional user profiles, to customise the beverages according to personal preferences. Refer to the “**Enabling a New Profile**” chapter.

ADJUSTMENTS

The machine allows for certain adjustments so that you can brew the best tasting coffee possible.

Coffee Profile

The machine allows to accommodate the individual preferences and settings of up to 6 different profiles.

The machine has 3 preset profiles, modelled on the various types of coffee on the market. The default one is indicated by the icon on the left.

You can create 3 additional profiles, which can be entirely customised. For a quick reference, users are represented by a unique icon, which has to be selected during programming.



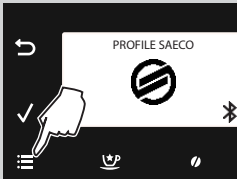

Enabling a New Profile

1 Press the  button to access the machine main menu.

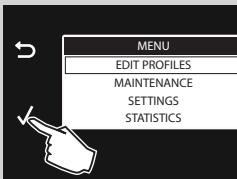

2 Press "" to confirm.



3 Press the "" button to select "ENABLE NEW PROFILE".

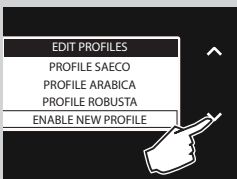



4 Press "✓" to confirm.

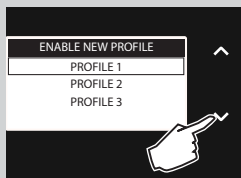

5 Press the "▼" button or the "▲" button to select the desired profile, which will be represented by a unique icon.



Note:

When a profile has already been enabled, it is not displayed in the possible options.

6 Press "✓" to confirm.



7 You can now customise beverages (see the **"Beverage Programming"** chapter).

Disabling a User Profile

You can disable an already enabled user profile, but not the preset profiles.



Note:

In this case, all the profile settings are kept in the memory but are not displayed. The respective icon is now available again in the enabling options. To enable the profile again, refer to the **"Enabling a New Profile"** section.

1 Press the "☰" button to access the machine main menu.

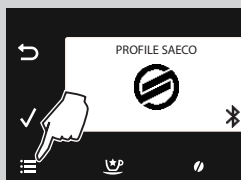



2 Press "✓" to confirm.

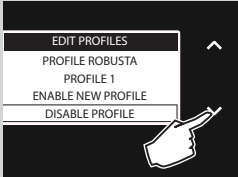

3 Press the "✓" button to select "DISABLE PROFILE".

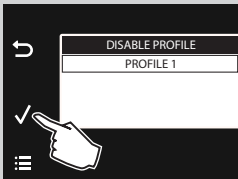

4 Press the "✓" button to select the profile to disable. Press the "✓" button to confirm. The profile is now disabled.



Note:

In this display all the profiles enabled earlier on will be shown. Only the selected profile will be disabled.

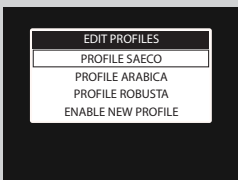

5 The following display is shown.

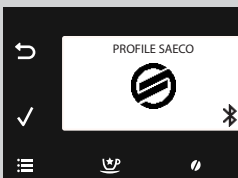

6 Press the "☰" button to exit the programming menu. Now the machine is ready for brewing.

Saeco Adapting System

Coffee is a natural product and its characteristics may change according to its origin, blend and roast. The machine is equipped with a self-adjusting system that allows the use of all types of coffee beans available on the market except for caramelized and flavoured coffee beans. The machine automatically adjusts itself after brewing several cups of coffee to optimize coffee extraction.

Adjusting the Ceramic Coffee Grinder

Ceramic coffee grinders always guarantee an accurate and perfect grinding and a specific coarseness for every coffee speciality. This technology provides full aroma preservation, delivering the truly Italian taste in every cup.



Warning:

The ceramic coffee grinder contains moving parts that may be dangerous. Do not insert fingers or other objects. Only adjust the ceramic coffee grinder using the grinder adjustment key.

You can adjust the ceramic grinders to set the coffee grinding to your personal taste.

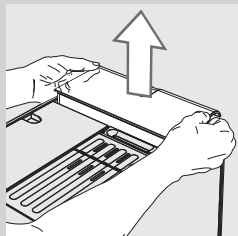

- 1 Remove the coffee bean hopper as shown in the "Removing the Coffee Bean Hopper" section.

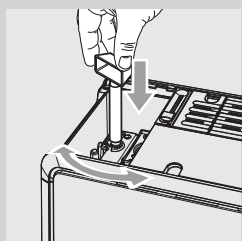

- 2 Press and turn the grinder adjustment knob under the coffee bean hopper **one notch at a time**. Use the coffee grinder adjustment key provided with the machine. You will taste the difference after brewing 2-3 cups of coffee.



Warning:

Do not turn the coffee grinder more than one notch at the time to prevent damage.

Adjusting the Dispensing Spout

The height of the coffee dispensing spout can be adjusted to better fit the dimensions of the cups that you wish to use.

Move the coffee dispensing spout up or down with your fingers to adjust its height as shown in the figure.

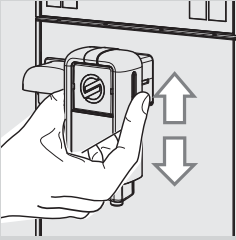

 **Note:**

when removing the dispensing spout to use large containers or for cleaning, make sure to insert it in the right direction during assembly. If you can see this triangle, the dispensing spout was assembled incorrectly.

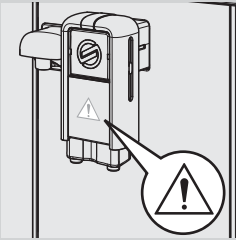

The recommended positions are:
For the use of small cups.

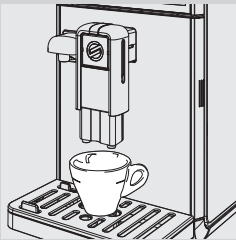

For the use of large cups.



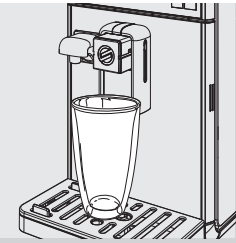

For the use of glasses for the Latte Macchiato.



Note:

This is possible by moving the dispensing spout towards the machine.

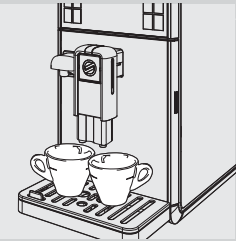

Two cups can be placed under the coffee dispensing spout to brew two coffees at the same time.

Adjusting the Coffee Quantity

The machine allows you to adjust the amount of brewed coffee or milk according to your taste and the size of your cups. Each time the Espresso “☕”, the Café Crème “☕”, the Coffee “☕” and the American Coffee “☕” buttons are pressed, the machine brews a preset amount of product. Each button may be individually programmed for a specific brew setting.

The following procedure describes the Espresso “☕” button programming.

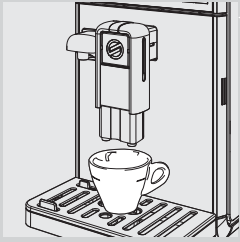

- 1 Place a cup under the coffee dispensing spout.

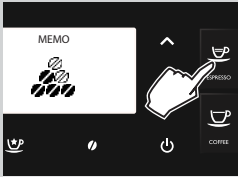

- 2 Press and hold the Espresso “☕” button until the “MEMO” icon appears on the display, then release the button. The machine is now in programming mode. The machine starts brewing coffee.

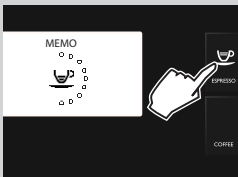

- 3 Press the Espresso “☕” button as soon as the desired amount of coffee is reached.

Now the Espresso “☕” button is programmed; each time it is pressed, the machine will brew the same amount of espresso that was just programmed.



Note:

Follow the same procedure for programming the Café Crème “☕”, Coffee “☕” and American Coffee “☕” buttons.

Once the desired amount is reached, press the selected brew button again to stop brewing.

You can also adjust the beverage length in the “EDIT PROFILES” (see the “Beverage Programming” chapter, “COFFEE AMOUNT” option).

BREWING COFFEE



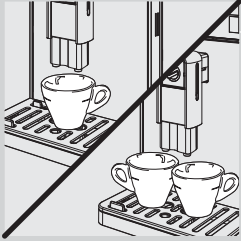

Before brewing coffee, make sure that there are no warnings shown on the display, and that the water tank and coffee bean hopper are filled.

Coffee Brewing Using Coffee Beans



- 1 Place 1 or 2 cups under the coffee dispensing spout.



- 2 Press the “” button for an Espresso, the “” button for a Café Crème, the “” button for a Coffee or the “” button for an American Coffee.

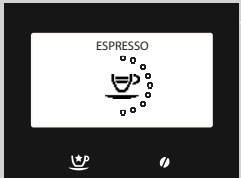

- 3 To brew 1 cup of coffee, press the desired button once. The following display is shown.



- 4 To brew 2 cups of coffee, press the desired button twice consecutively. The following display is shown.

Note:

In this operating mode, the machine automatically grinds and doses the proper amount of coffee.

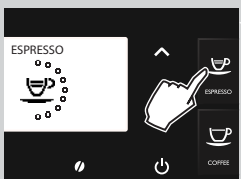

- 5 After the prebrewing cycle, coffee begins to pour out of the coffee dispensing spout.
- 6 Coffee brewing automatically stops when the preset level is reached; you can stop it earlier by pressing the same button that you pressed to start brewing.

Coffee Brewing Using Pre-Ground Coffee

This function allows you to use pre-ground and decaffeinated coffee. With the pre-ground coffee function you can only brew one coffee at a time.

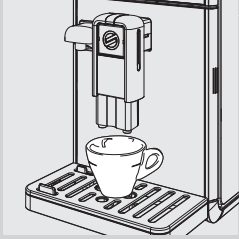

- 1 Place a cup under the coffee dispensing spout.



- 2 Press the "☉" button to access the aroma selection menu.

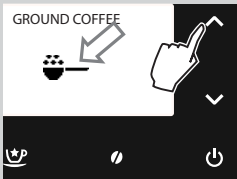

- 3 To select the pre-ground coffee brewing function, press the "✓" or "∧" scrolling button until the "☉" icon is displayed.



- 4 Press the "☉" button for an Espresso, the "☉" button for a Café Crème or the "☉" button for a Coffee.

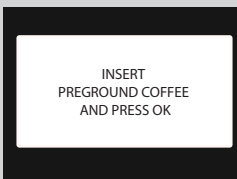

- 5 When choosing the product, the machine asks you to confirm that the ground coffee has been inserted.

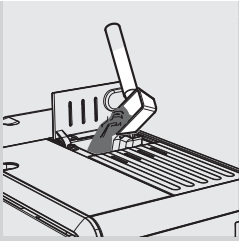

6 Open the pre-ground coffee compartment lid.

7 Add one measuring scoop of pre-ground coffee into the compartment. Use only the measuring scoop supplied with the machine. Then close the pre-ground coffee compartment lid.



Warning:

Add only pre-ground coffee into the pre-ground coffee compartment. Other substances and objects may cause severe damage to the machine. This repair is not covered by your warranty!



8 Press the "✓" button. After the prebrewing cycle, coffee begins to pour out of the coffee dispensing spout.

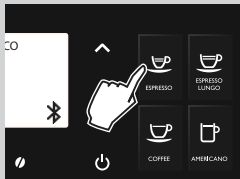

9 Coffee brewing automatically stops when the preset level is reached; press the same selected beverage button again to stop it earlier.

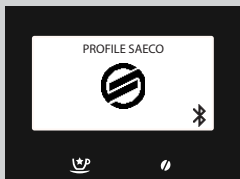

After brewing, the machine returns to the main menu.

Repeat the steps described above to brew more coffees using pre-ground coffee.



Note:

If no pre-ground coffee is poured into the compartment, only water will be dispensed.

If the dose is excessive or if 2 or more measuring scoops have been added, the machine will discharge the excess pre-ground coffee into the coffee grounds drawer. The brewing length cannot be saved for pre-ground coffee.



Note:

This function remains active for 30 seconds. Then the machine resets the selection and goes back to the earlier status.

MILK CARAFE

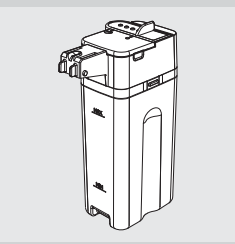

This chapter explains how to use the milk carafe to prepare milk-based beverages.



Note:

Before using the milk carafe, clean it thoroughly as described in the "Cleaning and Maintenance" chapter.

We recommend filling it with cold milk (approx. 5°C).



Warning:

Fill the carafe with milk for brewing beverages and with water for cleaning only.

Filling the Milk Carafe

The milk carafe can be filled before or during use.

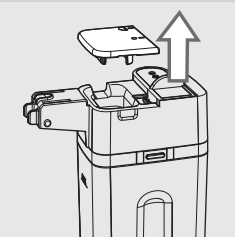

- 1 Lift the carafe lid as shown in the figure.

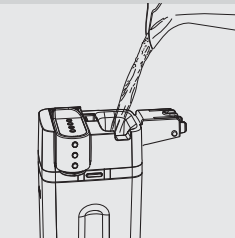

- 2 Pour the milk into the milk carafe: the milk level must be between the minimum (MIN) and maximum (MAX) level indicators shown on the milk carafe. Put the carafe lid back on.

- 3 The milk carafe is now ready for use.

Inserting the Milk Carafe

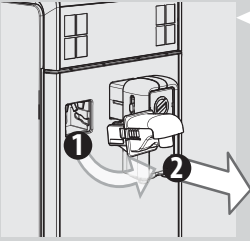

- 1** If installed, remove the water dispensing spout as shown in the figure:
 - Press the two buttons on the side to unlock it and lift it slightly;
 - Pull the hot water dispensing spout to remove it.

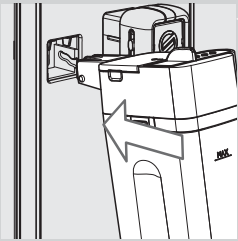

- 2** Slightly tilt the milk carafe. Insert it all the way into the guides of the machine.

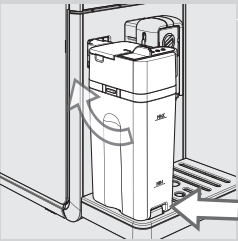

- 3** Push the carafe towards the bottom while rotating it at the same time, until it is locked onto the drip tray. Do not force the carafe while inserting it.

Removing the Milk Carafe

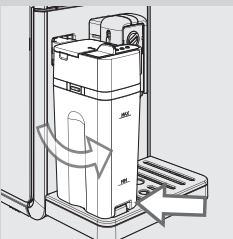

- 1** Rotate the carafe upwards until it is released from the insert in the drip tray. Then remove it.

Emptying the Milk Carafe

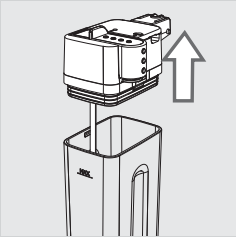
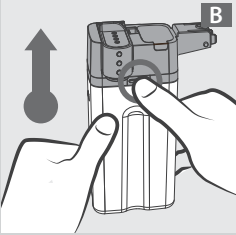
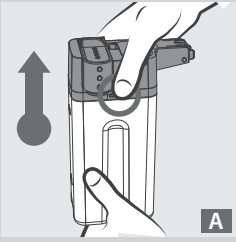

1 Press one of the release buttons to remove the top of the carafe as shown in the figures (A or B).

2 Lift the top of the carafe. Empty the milk carafe and clean it properly.



Note:

After each use, clean the milk carafe as described in the “Cleaning and Maintenance” chapter.

BREWING MILK-BASED BEVERAGES



Warning:

Danger of burning! Dispensing may be preceded by jets of milk and steam. Wait until the end of the cycle before removing the milk carafe.

The buttons to automatically prepare an Espresso Macchiato “☕”, a Cappuccino “☕”, a Latte Macchiato “☕” and a Hot Milk “☕” are displayed on the control panel.

The procedure for brewing a Cappuccino “☕” is shown as an example.

- 1 Fill the milk carafe with milk. The milk level must be between the minimum (MIN) and maximum (MAX) level indicators shown on the milk carafe. Put the carafe lid back on.

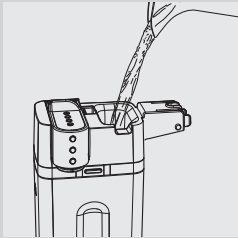

Note:

Use cold (~5 °C / 41°F) milk with a protein content of at least 3% to ensure optimum results when preparing a cappuccino. Whole milk or skimmed milk may be used depending on individual taste.

- 2 Insert the carafe into the machine.

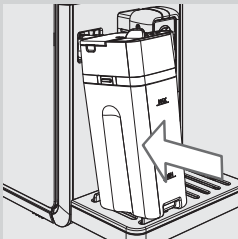

- 3 Pull out the carafe dispenser to the right up to the “☕” icon. Make sure that the dispensing spout handle is perfectly aligned to the icon “☕”.

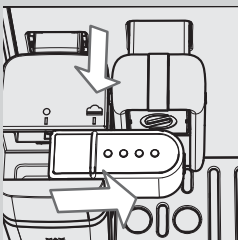

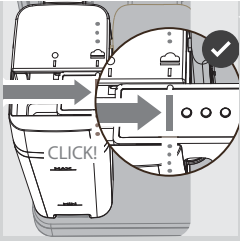

4 When the carafe dispenser is correctly positioned you will hear a **CLICK!**



Note:

If the carafe dispenser has not been pulled all the way out, steam may escape and milk may not be properly frothed.

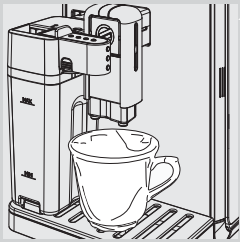

4 Place a cup under the carafe dispenser.



5 Press the Cappuccino “” button to start brewing.

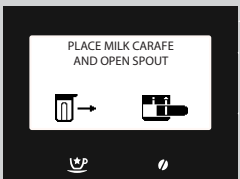

6 The machine reminds you to insert the carafe and remove the carafe dispenser.

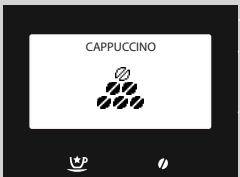

7 The machine grinds the predefined quantity of coffee.



- 8 The following screen is displayed during the preheating time required by the machine.



- 9 The machine starts dispensing milk. To stop the dispensing process, press the same selected beverage button that you pressed previously. Dispensing will stop in a few seconds.

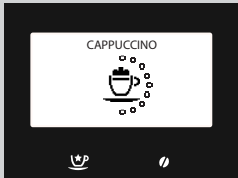

- 10 Once frothed milk has been dispensed, the machine brews coffee. To stop brewing, press the same selected beverage button that you pressed previously.

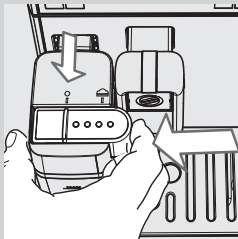

- 11 When brewing has been completed, if you do not wish to perform an automatic carafe rinse cycle, close the carafe dispenser by sliding it to the "●" icon.

**Note:**

After using the milk carafe, clean it as described in the "Cleaning and Maintenance" chapter.

**Note:**

Follow the same steps to prepare an Espresso Macchiato "☕", a Latte Macchiato "☕" or a Hot Milk "☕". When you reach step 5, press the desired product button.

Quick Carafe AUTO CLEAN Cycle

After one or more milk-based products have been prepared, the machine allows for a quick cleaning of the carafe ducts.

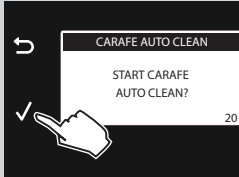

- 1 The following screen is displayed for 20 seconds. Press the "✓" button to start the cycle.



Note:

if you wish to prepare another milk-based beverage or do not wish to perform the rinse cycle, press the "↶" button.

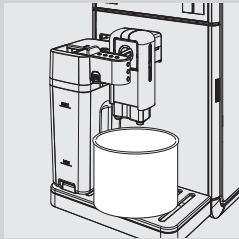

- 2 Pull out the carafe dispenser to the right up to the "☰" icon. Place a container under the carafe dispenser.

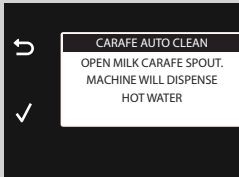

- 3 Press the "✓" button.



- 4 The display shows that the cycle is being performed. Once the cycle has been completed, close the carafe dispenser by sliding it to the "●" icon and empty the container.

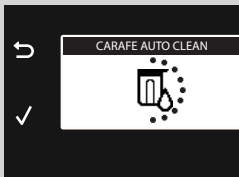

Adjusting the Milk-Based Product Length

Every time the Espresso Macchiato “☕”¹, the Cappuccino “☕”², the Latte Macchiato “☕”³ and the Hot Milk “☕”⁴ buttons are pressed, the machine brews a preset amount of selected beverage into the cup. The machine allows you to adjust the amount of each beverage according to your taste and the size of your cups.

The procedure for programming a Cappuccino “☕”² is shown as an example.

- 1 Fill the carafe with milk and insert it into the machine.
- 2 Pull out the carafe dispenser to the right up to the “☕”² icon. Place a cup under the carafe dispenser.

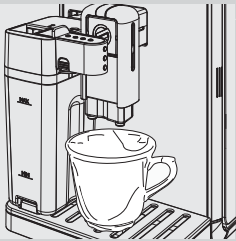

- 3 Press and hold the Cappuccino “☕”² button until the following display is shown, then release the button. The machine reminds you to insert the carafe and remove the carafe dispenser. The machine is now in programming mode.

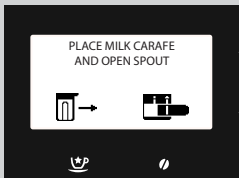

- 4 The machine grinds the predefined quantity of coffee.

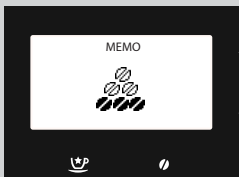



- 5 This icon is displayed during the preheating time required by the machine.

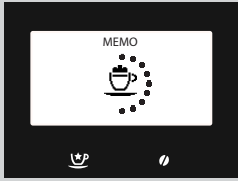

- 6 When this icon is shown, the machine starts dispensing frothed milk into the cup. Once the desired amount of frothed milk is reached, press the same selected beverage button that you pressed previously. Dispensing will stop in a few seconds.



Note:

If you are dispensing a Hot Milk , the dispensing process ends with step six.

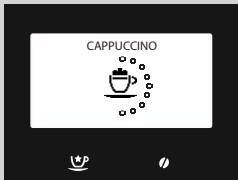



- 7 Once frothed milk has been dispensed, the machine starts brewing coffee. When the desired quantity is reached, press the same selected beverage button that you pressed previously.

Now the Cappuccino  button is programmed. Every time it is pressed, the machine will brew the same amount of cappuccino that was programmed.



Note:

Follow the same steps to prepare an Espresso Macchiato , a Latte Macchiato  or a Hot Milk . When you get to step 3, press the desired product button.



SPECIAL BEVERAGES



The machine is designed to brew more products than those described so far. For this, follow the steps below:

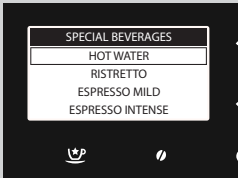

- 1 Press the " button to access the "SPECIAL BEVERAGES" menu.



- 2 Select the beverage by pressing the " button or the " button. Then press the " button to start brewing.

- 3 To stop the beverage brewing, press the Special Beverages " button again or press the " button.



Note:

If you press the Special Beverages " button without choosing any product, the machine returns to the main menu after 3 minutes.

With the special beverages function you can only brew one beverage at a time. To brew more beverages, repeat the procedure.

Hot Water



Warning:

Danger of burning! Dispensing may be preceded by small jets of hot water and steam. Wait until the end of the cycle before removing the water dispensing spout.

- 1 Remove the milk carafe, if inserted. Slightly tilt the water dispensing spout and insert it all the way into the guides of the machine.

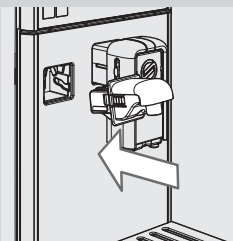

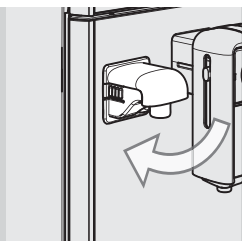

- 2 Push the water dispensing spout towards the bottom while rotating it at the same time, until it is locked into the machine as shown in the figure.

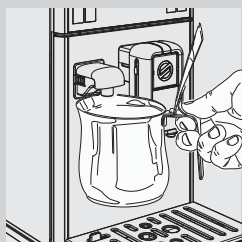

- 3 Place a container under the hot water dispensing spout.

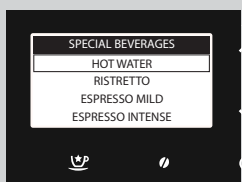

- 4 Press the "✓" button to access the "SPECIAL BEVERAGES" menu.

- 5 Press the "✓" button to start brewing.

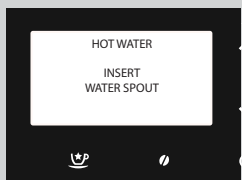

- 6 This icon is displayed. The machine reminds you to install the water dispensing spout. Check that the water dispensing spout is correctly installed. Press "✓" to confirm. The machine will start dispensing hot water.

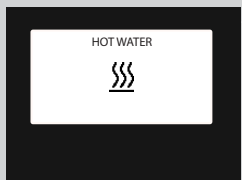

- 7 This icon is displayed during the preheating time required by the machine.

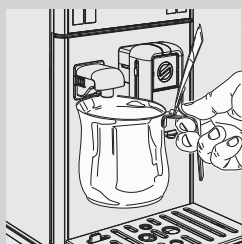





- 8 Dispense the desired amount of hot water.
To stop dispensing hot water, press the "↶" button.

Adjusting Hot Water Dispensing



Warning:

Danger of burning! Dispensing may be preceded by small jets of hot water and steam. Wait until the end of the cycle before removing the water dispensing spout.

- 1 Make sure that the machine is ready for the hot water dispensing.
- 2 Press the "P" button to access the "SPECIAL BEVERAGES" menu.
- 3 Press the "" button until this display is shown, then release the button.
- 4 Press "" to confirm. The machine will start dispensing hot water.
- 5 This icon is displayed during the preheating time required by the machine.
- 6 Dispense the desired amount of hot water.
To stop the hot water dispensing, press the Special Beverages "P" button again.

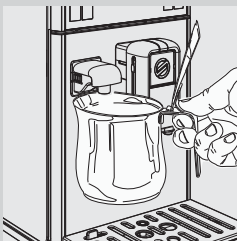
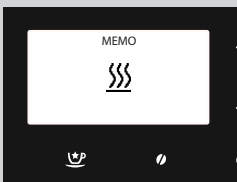
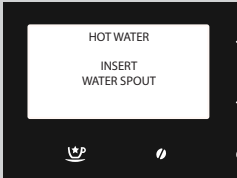

The amount of water to dispense is now programmed. Every time it is selected, the machine will dispense the same amount of hot water that was programmed.

Special Beverages Menu for Brewing Other Beverages

The menu allows you to brew other beverages, according to your personal taste.

The procedure for brewing a strong coffee is shown as an example.



Note:

Follow the same steps to brew the other menu beverages. Only when you are brewing a "Flat white" you need to prepare the machine as for brewing a Cappuccino.

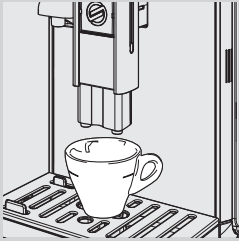

- 1 Place 1 cup under the coffee dispensing spout.

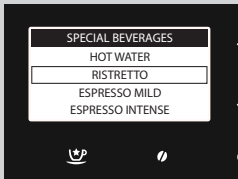

- 2 Press the "☺P" button to access the "SPECIAL BEVERAGES" menu.
- 3 Select the beverage by pressing the "▼" button until you reach the "RISTRETTO" option.
- 4 Press the "✓" button to start brewing.
- 5 Coffee brewing automatically stops when the preset level is reached; press the "Special beverages" "☺P" button again to stop it earlier.

Adjusting the Other Beverages Quantity for the "Special Beverages" Menu

This procedure allows you to adjust the quantity of the other beverages displayed on the menu, according to personal taste.

The procedure for brewing a strong coffee is shown as an example.



Note:

Follow the same steps to brew the other menu beverages. Only when you are brewing a "Flat white" you need to prepare the machine as for brewing a Cappuccino.

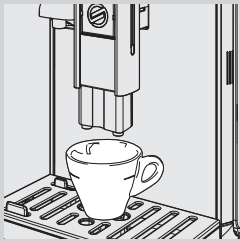

- 1 Place 1 cup under the coffee dispensing spout.



- 2 Press the " button to access the "SPECIAL BEVERAGES" menu.

- 3 Select the beverage by pressing the " button until you reach the "RISTRETTO" option.

- 4 Press and hold the " button until the "MEMO" icon appears on the display, then release the button. The machine is now in programming mode.

The machine starts brewing coffee.

- 5 Press the " button as soon as the desired amount of coffee is reached.

Now the beverage is programmed; each time it is selected, the machine will brew the same amount that was just programmed.



Note:

Only when you are brewing a "Flat white" you need to program the amount of milk and coffee separately, as shown for brewing a Cappuccino.

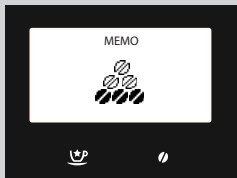

BEVERAGE PROGRAMMING

The machine allows you to customise every beverage according to your personal taste and to save the preferences in your personal profile.

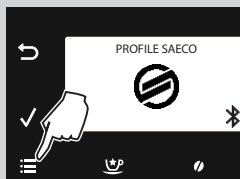

1 Press the  button to access the machine main menu.

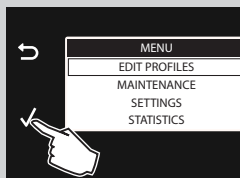

2 Press "" to confirm.

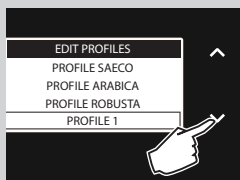

3 Press the "" button to select the enabled profile in which you wish to program the beverage.

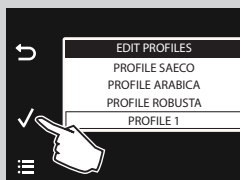

4 Press "" to confirm.



Note:

The parameters to adjust for brewing a cappuccino are shown as an example. Follow the same steps to adjust other beverages. The milk parameters are not available for the coffee-only beverages.

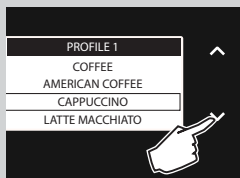

5 Press the "" button to select "**CAPPUCCINO**".

6 Press "" to confirm.

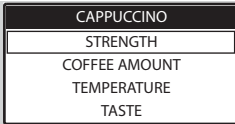

The parameters to adjust are displayed.

To select them, press the "▼" or "▲" scrolling button.
To access, press the "✓" button.

To return to the previous screen, press the "↶" button.
To return to the initial screen, press the "☰" button.

Aroma



This setting adjusts the amount of coffee to ground.

●●●●●● = very mild aroma
 ●●●●●● = mild aroma
 ●●●●●● = regular aroma
 ●●●●●● = strong aroma
 ●●●●●● = very strong aroma
 ●●●●●● = extra strong aroma
 ☞ = ground coffee

Press the "▼" or "▲" scrolling button to select, then press the "✓" button to confirm.

Coffee Quantity

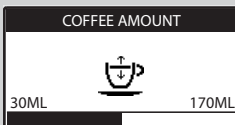

By adjusting the bar on the display with the "▼" or "▲" scrolling button, you can choose the amount of water used for coffee brewing.
Press "✓" to confirm the adjustment.

Temperature

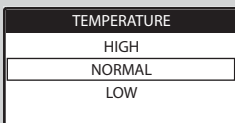

This setting allows you to adjust the coffee temperature.

LOW : low temperature.

NORMAL : medium temperature.

HIGH : high temperature.

Press the "▼" or "▲" scrolling button to select, then press the "✓" button to confirm.

Taste



This setting enables the prebrewing function. During prebrewing, the coffee is slightly dampened to bring out the aroma in full.

DELICATE: prebrewing function is not performed.

BALANCED: prebrewing function is enabled.

FULL BODY: prebrewing function lasts longer to enhance the coffee taste.

Press the "▼" or "▲" scrolling button to select, then press the "✓" button to confirm.

Milk Quantity



By adjusting the bar on the display with the "▼" or "▲" scrolling button, you can choose the quantity of milk to use for the selected beverage. Press "✓" to confirm the adjustment.



Note:

The milk adjusting options are displayed only for the milk-based beverages.

HOT WATER PROGRAMMING

The following procedure describes the programming of hot water.

- 1 Press the "▼" button to select "HOT WATER".
- 2 Press "✓" to confirm.



Water Quantity

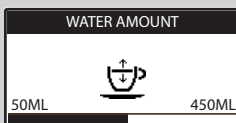

By adjusting the bar on the display with the "▼" or "▲" scrolling button, you can choose the quantity of water to be dispensed. Press "✓" to confirm the adjustment.

Temperature

TEMPERATURE
HIGH
NORMAL
LOW

This setting allows you to adjust the coffee temperature.

LOW : low temperature.

NORMAL : standard temperature.

HIGH : high temperature.

Press the "▼" or "▲" scrolling button to select, then press the "✓" button to confirm.

RESTORING BEVERAGE PARAMETERS

The factory setting of every beverage can be restored for each profile.

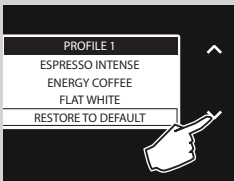

1 Press the "▼" button to select "**RESTORE TO DEFAULT**".

2 Press "✓" twice to confirm. All the parameters are restored to factory settings.



Note:

Through this option all the customised settings programmed by the user are deleted.

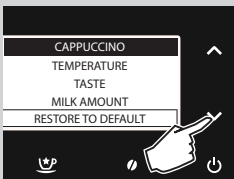

The factory setting of every beverage can be restored for each parameter.

1 When the desired beverage has been selected, press the "▼" button to select "**RESTORE TO DEFAULT**".

2 Press "✓" twice to confirm. All the parameters are restored to factory settings.



Note:

Through this option all the customised settings programmed by the user for the selected product are deleted.

MACHINE PROGRAMMING

The machine allows you to customise the operating settings. These settings are applied to all user profiles.

1 Press the "☰" button to access the machine main menu.

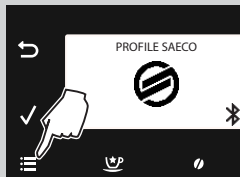

2 Press the "✓" button to select "SETTINGS".

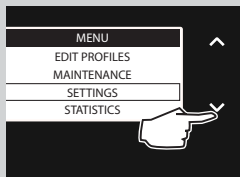

3 Press "✓" to confirm.

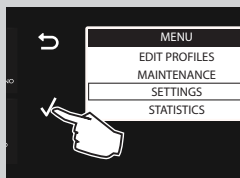

The parameters to adjust are displayed here.

To select them, press the "∨" or "∧" scrolling button.

To access, press the "✓" button.

To return to the previous screen, press the "↶" button.

To return to the initial screen, press the "☰" button.

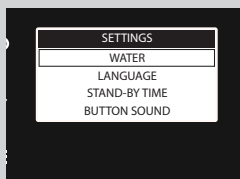

Water settings

The **WATER SETTINGS** option allows you to adjust the water parameters for an optimal coffee.

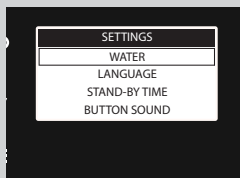

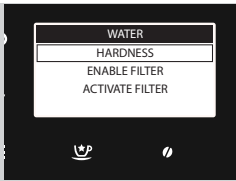

Under **HARDNESS** you can set the water hardness level. For water hardness measuring, refer to the “Measuring and Programming Water Hardness” chapter.

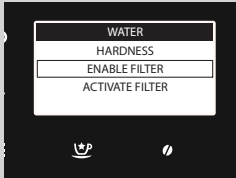

Under **ENABLE FILTER** the machine notifies the user when the water filter needs to be replaced.

- OFF:** Filter and warning disabled. (**Default value**) By setting the value on OFF you disable the filter and the replacement warning.
- ON:** Filter and warning enabled (this warning is automatically set when the filter is activated).



Under **ACTIVATE FILTER** you activate the filter after its installation or replacement. Refer to the “INTENZA+ Water Filter Installation” chapter.

Language Settings



This setting is important to automatically adjust the machine parameters according to the user's country.

Stand-by Settings

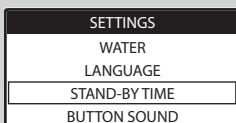

The **STAND-BY** sets the time lapse for the machine to go into stand-by mode after last brewing. The stand-by time ranges among 15, 30, 60 and 180 minutes.

The default time value is 15 minutes.

Button Sound

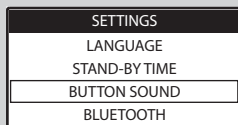

This setting allows the machine to produce a sound each time a button is pressed.

OFF: Tone deactivated

ON: Tone activated

Bluetooth

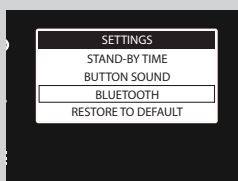

The **BLUETOOTH** menu allows you to connect the machine to a mobile device compatible with this technology.

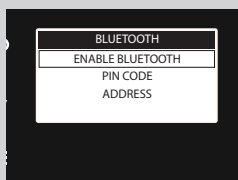

In **ENABLE BLUETOOTH** you find the options to activate the function.

OFF: Bluetooth deactivated (the machine cannot connect to mobile devices).

ON: Bluetooth activated (the machine can connect to mobile devices).

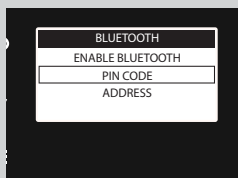

In **PIN CODE** you find the code that you are prompted to enter when connecting to mobile devices.

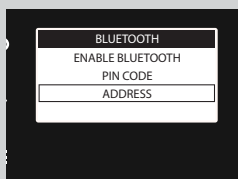

In **ADDRESS** you find the ID number of the Bluetooth module on the machine.

Factory Settings

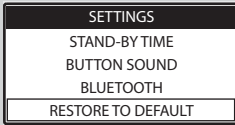

Activating the **RESTORE TO DEFAULT** option will restore all machine settings to their default values. In this case all customised parameters will be deleted.

STATISTICS

The machine allows you to see how many beverages have been brewed. This allows you to schedule the various maintenance operations indicated in the instruction manual.

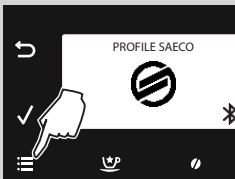

- 1 Press the "≡" button to access the machine main menu.



- 2 Press the "✓" button to select "STATISTICS".
- 3 Press "✓" to confirm.

The amount of brewed beverages, divided for each option, will be displayed.

MAINTENANCE

In this menu you can manage all the automatic cycles necessary for the correct maintenance of the machine.

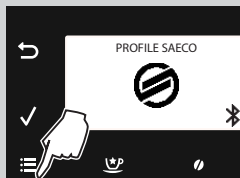

1 Press the “☰” button to access the machine main menu.

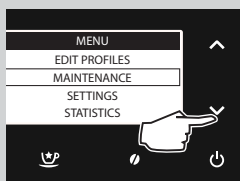

2 Press the “✓” button to select “MAINTENANCE”.

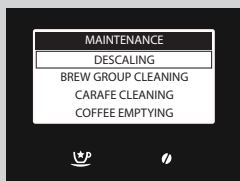

3 Press “✓” to confirm.

4 Press the “∨” or “∧” button to select the cycle to activate.

The various cycles to activate are displayed here.

Descaling

The **DESCALING** function activates the descaling cycle (see the “Descaling” chapter).

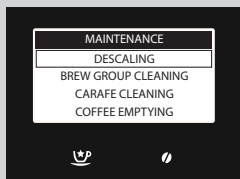

Brew Group Cleaning Cycle

The **BREW GROUP CLEANING** function enables the brew group monthly cleaning (see the “Monthly Cleaning of the Brew Group” chapter).

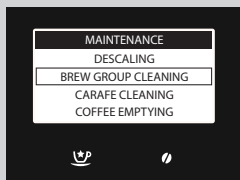

Cleaning of the Carafe

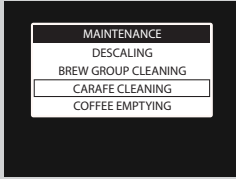

The **CARAFE Cleaning** menu allows you to manage the carafe cleaning.

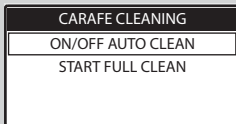

In **ON/OFF AUTO CLEAN** you find the options to manage the “**Quick Rinse Cycle**” displayed after dispensing a milk-based beverage.

OFF: Cycle deactivated.

ON: Cycle activated.

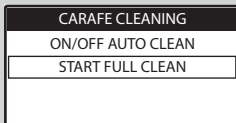

In **START FULL CLEAN** you can start the milk carafe cleaning (see the “Monthly Cleaning of the Milk Carafe” chapter).

Coffee Circuit Cleaning

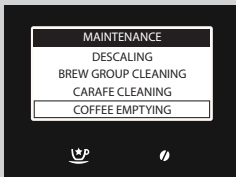

The **COFFEE EMPTYING** function enables the coffee circuit cleaning (see the “Coffee Emptying Cycle” chapter).

CLEANING AND MAINTENANCE

Daily Cleaning of the Machine



Caution:

Timely cleaning and maintenance of your machine is very important as it prolongs the life of your machine. The machine is continuously exposed to humidity, coffee and limescale! The activities you need to perform and their frequency are described in detail in this chapter. Not doing this will ultimately make your machine stop working properly. This repair is NOT covered by warranty!



Note:

- Use a soft, dampened cloth to clean the machine.
- Only the cup holder grill, the internal drip tray, the coffee grounds drawer and any parts of the carafe described in the "Weekly Cleaning of the Milk Carafe" section can be washed in the dishwasher. Any other components must be washed with lukewarm water.
- Do not immerse the machine in water.
- Do not use alcohol, solvents, and/or abrasive objects to clean the machine.
- Do not dry the machine and/or its components using a microwave and/or standard oven.

Empty and clean the coffee grounds drawer and the drip tray (internal) every day with the machine turned on. Please follow the steps below:

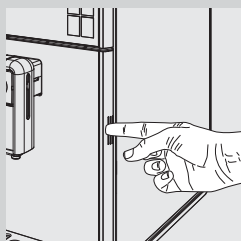

- 1** Press the button in the frame and open the service door.

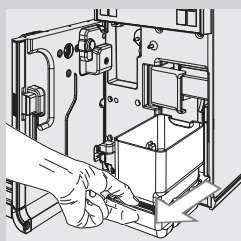

- 2** Remove the drip tray (internal) and coffee grounds drawer.

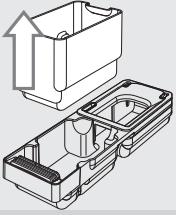

3 Empty the coffee grounds drawer and wash it with fresh water.

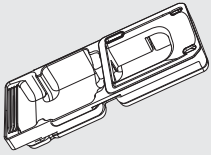

4 Empty the drip tray (internal) and the lid and wash them with fresh water.

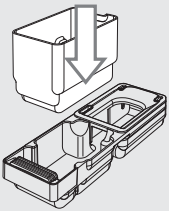

5 Correctly reinstall all the components.

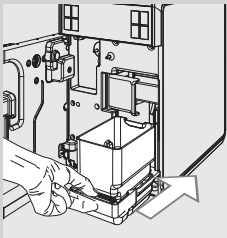

6 Insert the drip tray and the coffee grounds drawer and close the service door.

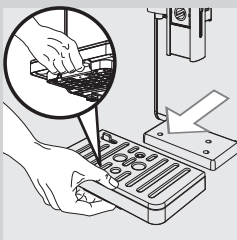

7 Press the lever on the bottom and remove the drip tray (external), empty it and wash it.

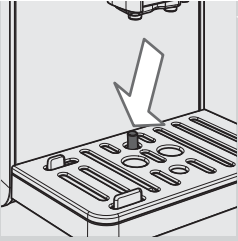
**Note:**

Perform this operation also when the full drip tray indicator is raised.

Daily Cleaning of the Water Tank

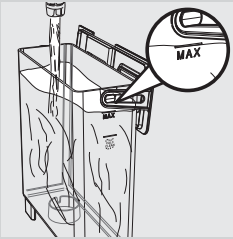

- 1 Remove the small white filter or the INTENZA+ water filter (if installed) from the water tank and wash both with fresh water.
- 2 Put the small white filter back or the INTENZA+ water filter (if installed) in its housing by gently pressing and turning it at the same time.
- 3 Fill the water tank with fresh water.

Daily Cleaning of the Milk Carafe

In addition to the quick carafe rinse cycle, we recommend that you also clean the carafe daily as described below. This preserves hygiene and ensures a perfect frothed milk consistency.

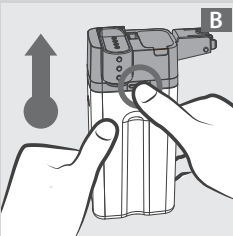
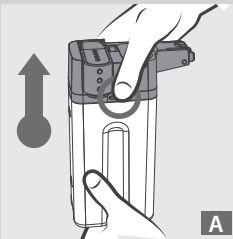

- 1 Press one of the release buttons to remove the top of the carafe as shown in the figures (A or B).

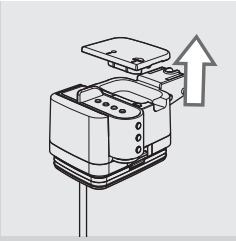

2 Remove the lid.

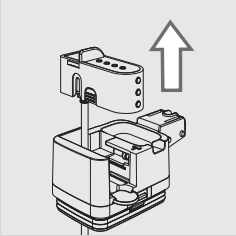

3 Lift the carafe dispenser to remove it from the top of the carafe.

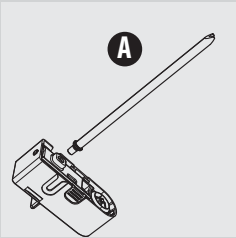

4 Remove the suction tube with the fitting (A) from the milk frother.

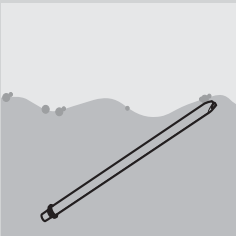

5 Wash the suction tube with the fitting thoroughly with fresh water.

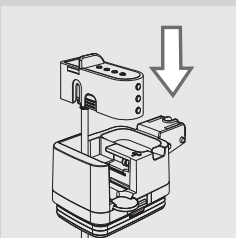

6 After installing the suction tube with the fitting, insert the carafe dispenser on the top of the carafe.

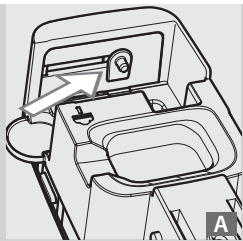

Note:

If you cannot install the dispenser on the top of the carafe, the pin is in the wrong position (B). Before installing the dispenser, manually push the pin to the (A) position.

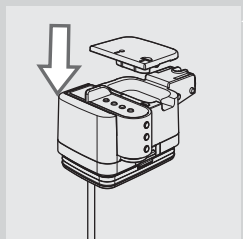
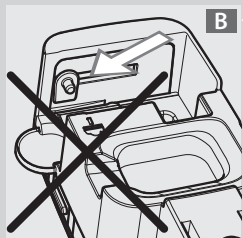

7 Insert the lid.

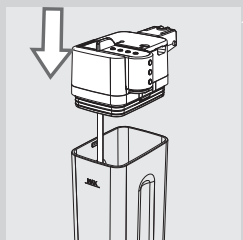

8 Place the top of the carafe back in position.

Weekly Cleaning of the Milk Carafe

The weekly cleaning is more thorough since all milk residues are removed from the dispenser.

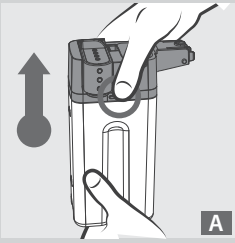

A

- 1 Press one of the release buttons to remove the top of the carafe as shown in the figures (A or B).

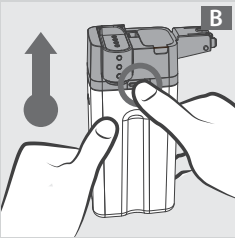

B

- 2 Remove the lid.

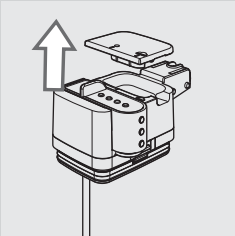

- 3 Lift the carafe dispenser to remove it from the top of the carafe. The carafe dispenser is made up of six parts that must be disassembled. Each part is indicated by a capital letter (A, B, C, D, E, F).

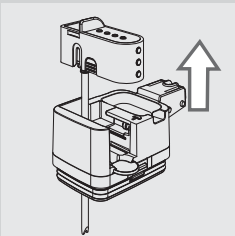

- 4 Remove the suction tube with the fitting (A) from the milk frother.

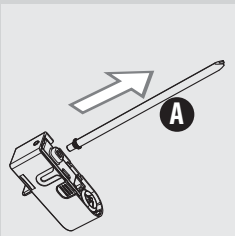

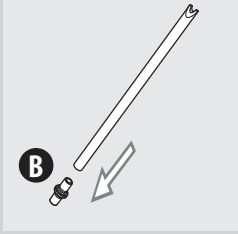

5 Remove the fitting (B) from the suction tube.

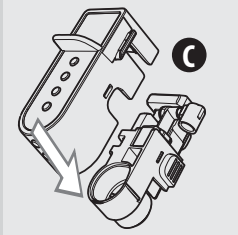

6 Detach the lid (C) from the milk carafe dispenser by slightly pressing on the sides while pushing downwards.

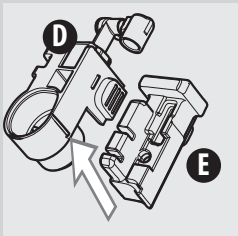

7 Remove the milk frothing device (D) from the support (E).

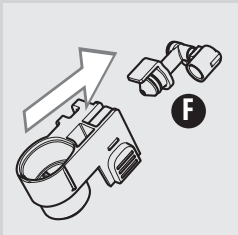

8 Remove the fitting (F) from the milk frothing device by pulling it outwards.

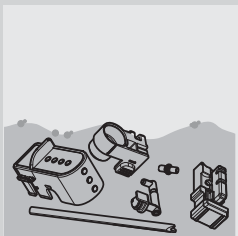

9 Clean all the parts thoroughly with lukewarm water.



Note:

You can also clean these parts in the dishwasher.

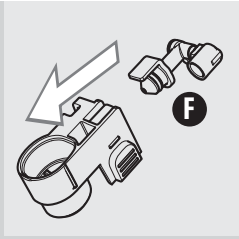

10 Insert the fitting (F) into the milk frothing device by pressing it up to its limit.

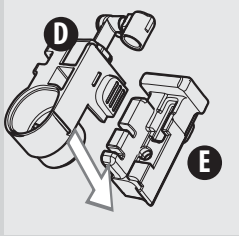

11 Insert the milk frothing device (D) into the support (E).

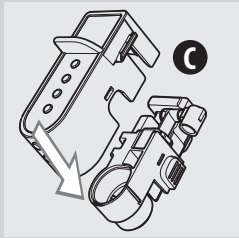

12 Attach the top (C) to the carafe dispenser.

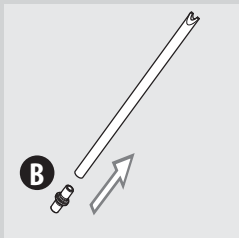

13 Insert the fitting (B) into the suction tube.

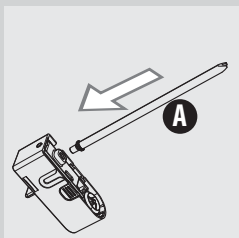

14 Insert the suction tube with the fitting (A) into the milk frother.

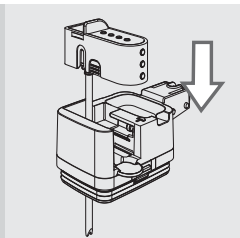

15 Insert the dispenser on the top of the carafe.

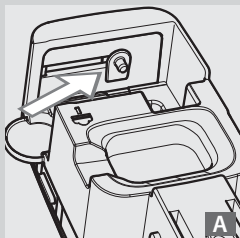

Note:

If you cannot install the dispenser on the top of the carafe, the pin is in the wrong position (B). Before installing the dispenser, manually push the pin to the (A) position.

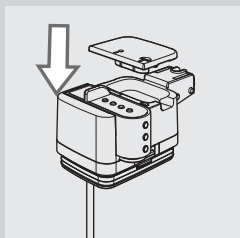
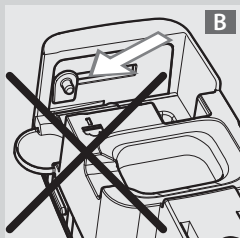

16 Insert the lid.

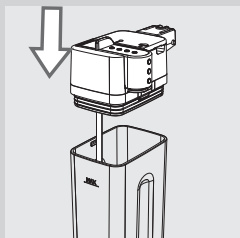

17 Attach the top of the milk carafe, ensuring it is locked into place.

Weekly Cleaning of the Brew Group

The brew group should be cleaned every time the coffee bean hopper is filled or at least once a week.

- 1 Turn off the machine by pressing the “” button and remove the plug from the socket.

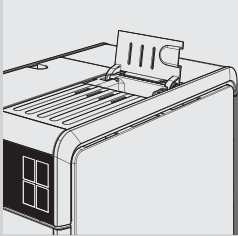

- 2 Open the pre-ground coffee compartment lid.

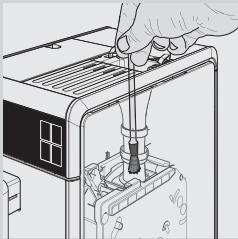

- 3 Thoroughly clean the pre-ground coffee compartment with the cleaning brush, making sure that there are no more coffee residues in the duct.

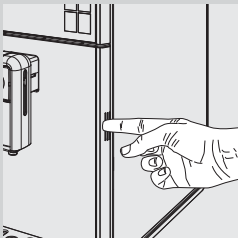

- 4 Press the button in the frame and open the service door.

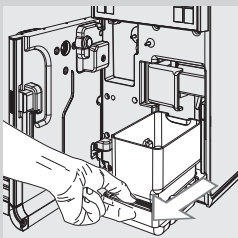

- 5 Remove the drip tray (internal) and coffee grounds drawer and clean them.

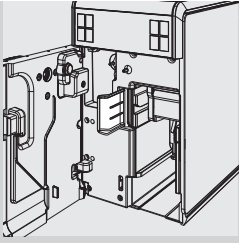

6 Open the brew group unlocking lever.

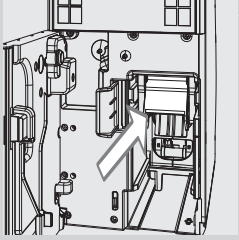

7 Seize the brew group handle and pull it outwards.

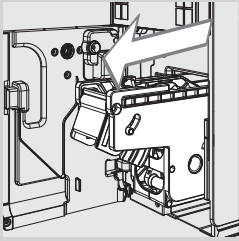

8 While pulling the lever, remove the brew group.

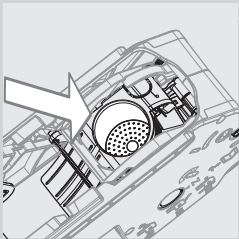

9 Thoroughly wash the brew group with lukewarm water and carefully clean the brew group filter.



Caution:

Do not use detergent or soap to clean the brew group.

10 Let the brew group air-dry thoroughly.

11 Thoroughly clean the inside of the machine using a soft, dampened cloth.

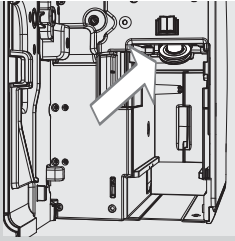

- 12** Thoroughly clean the upper screen using a non-abrasive cloth, to remove any coffee grounds.



Warning:

Danger of burning! The upper screen is a hot component. Make sure that the machine has cooled down, before cleaning. Perform the operation when the machine has been turned off for at least one hour.

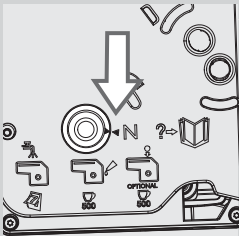

- 13** Make sure that the brew group is in the off position; the two reference marks must match. If they do not match, proceed as described in steps (14 and 15).

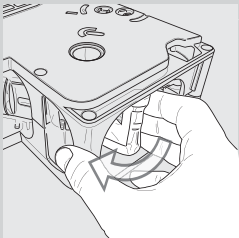

- 14** Turn the brew group back to the off position by manually turning the pin on the base, as shown in this figure. Turn it until it locks into the position described in the following step.

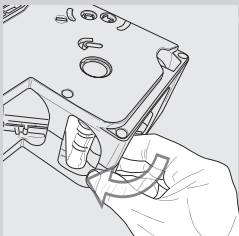

- 15** When you reach the position shown in this figure, check that the two reference signs match and that the brew group is locked into position.

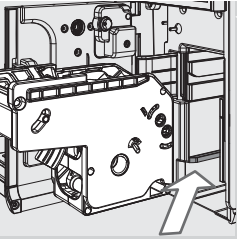

16 Insert the brew group back into its seat by sliding it along the guides until it locks into place.

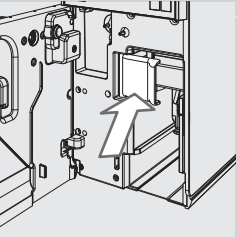

17 Close the brew group locking lever to lock it into position.

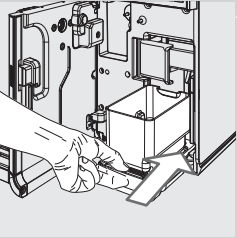

18 Insert the drip tray (internal) and coffee grounds drawer.

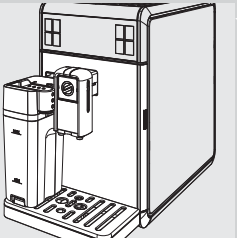

19 Close the service door.

Weekly Cleaning of the Coffee Bean Hopper, Tray and Coffee Compartment

Clean the coffee bean hopper, tray and coffee compartment once a week with a cloth to remove any coffee residues and dust.

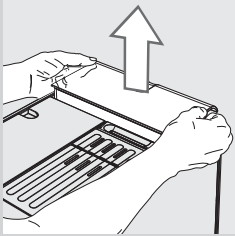

- 1 Remove the coffee bean hopper as shown in the "Removing the Coffee Bean Hopper" section.

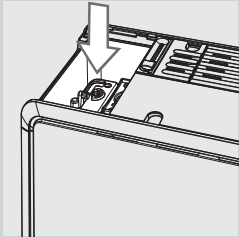

- 2 Clean the coffee compartment with a cloth to remove any coffee residues and dust.



- 3 Empty any beans out of the coffee bean hopper.

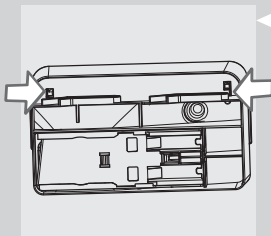

- 4 To remove the tray, press on the hooks on the bottom of the coffee bean hopper as shown in the image on the left.

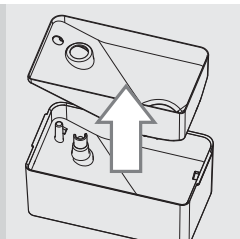

- 5** Remove the tray. Clean the tray and the coffee bean hopper with a wet cloth.

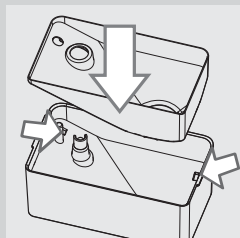

- 6** After cleaning and drying the tray, insert it back into the coffee bean hopper. Insert the tray hooks into their seats on the coffee bean hopper.

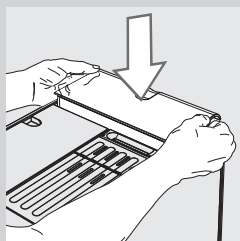

- 7** Insert the coffee bean hopper into the compartment.

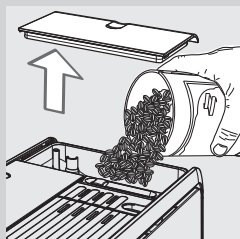

- 8** Slowly pour in the coffee beans. Put the lid.

Monthly Cleaning of the Milk Carafe



For the monthly cleaning cycle we recommend using the “Saeco Milk Circuit Cleaner” to keep the entire circuit clean of milk residues. The “Saeco Milk Circuit Cleaner” can be purchased separately. Please refer to the maintenance products page for further details.



Warning:

Danger of burning! Dispensing may be preceded by small jets of hot water and steam. Danger of burning! Wait until the end of the cycle before removing the milk carafe.



1 Press the “☰” button to access the machine main menu.

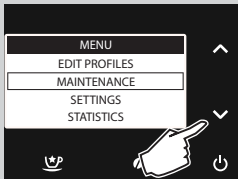

2 Press the “✓” button to select “**MAINTENANCE**”.

3 Press “✓” to confirm.

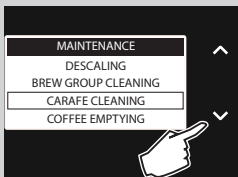

4 Press the “✓” button to select “**CARAFE CLEANING**”.

5 Press “✓” to confirm.

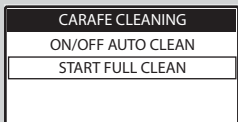

6 Press the “✓” button to select “**START FULL CLEAN**”.

7 Press “✓” to confirm.

CARAFE CLEANING
 START CARAFE
 FULL CLEAN?
 (~ 5 MINUTES)

8 Press "✓" to confirm or "↶" to return to the previous menu.

CARAFE CLEANING
 REFILL
 WATER TANK

9 Fill the water tank with fresh water up to the MAX level. Press the "✓" button to confirm.

CARAFE CLEANING
 POUR DETERGENT
 INTO CARAFE & FILL
 WITH WATER

10 Pour one milk cleaner bag into the milk carafe. Fill the milk carafe with fresh drinking water up to the MAX level and then let the milk cleaner bag dissolve completely.

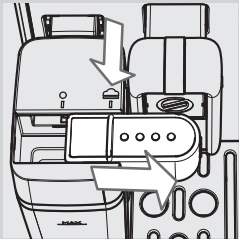
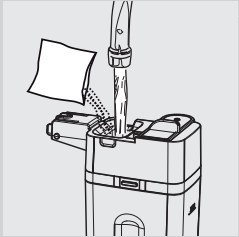

11 Insert the carafe into the machine. Slide the carafe dispenser to the right up to the "☞" icon. Press the "✓" button to confirm.

CARAFE CLEANING
 PLACE MILK CARAFE
 AND OPEN SPOUT

12 Press "✓" to confirm.

CARAFE CLEANING

PLACE CONTAINER
UNDER THE CARAFE
DISPENSING SPOUT

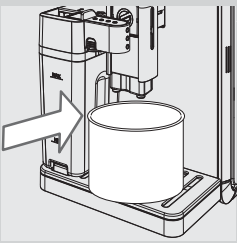

- 13** Place a large container (1.5 l) under the dispensing spout. Press the "✓" button to confirm. The machine starts dispensing the solution through the milk dispensing spout.

CARAFE CLEANING



- 14** The following display shows the cycle progress.



Warning:
Never drink the solution dispensed during this step.

CARAFE RINSING

REFILL
WATER TANK

- 15** When the machine stops dispensing, fill the tank with fresh water up to the MAX level. Press the "✓" button to confirm.

CARAFE RINSING

FILL CARAFE
WITH FRESH WATER

- 16** Remove the milk carafe and the container from the machine.

- 17** Rinse thoroughly the milk carafe and fill it with fresh drinking water up to the MAX level. Insert the milk carafe into the machine. Press the "✓" button to confirm.

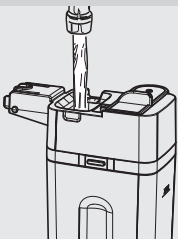

CARAFE RINSING

PLACE MILK CARAFE
AND OPEN SPOUT

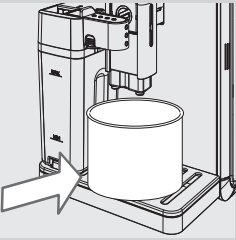

18 Empty the container and place it back under the coffee dispensing spout. Press the "✓" button to confirm.

CARAFE RINSING

PLACE CONTAINER
UNDER THE CARAFE
DISPENSING SPOUT

19 Press "✓" to confirm.

CARAFE RINSING



20 The machine will start dispensing water from the milk dispensing spout. The following display is shown.

21 At the end of the cycle, the machine is ready to brew products.

22 Disassemble and wash the milk carafe as described in the "Weekly Cleaning of the Milk Carafe" chapter.

Monthly Lubrication of the Brew Group

Lubricate the brew group after approximately 500 cups of coffee or once a month.

You can purchase the Saeco grease to lubricate the brew group separately. For further details, please refer to the maintenance products page in this user manual.

 **Caution:**

Before lubricating the brew group, clean it with fresh water and dry it as described in the “Weekly Cleaning of the Brew Group” chapter.

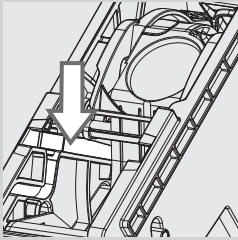

- 1** Apply the lubricant evenly on both side guides.

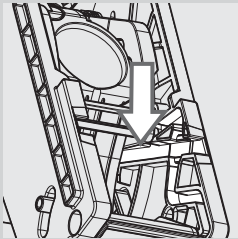

- 2** Lubricate also the piston, as shown in the figure.

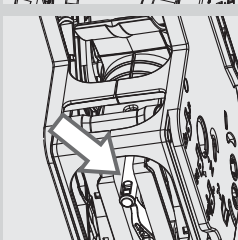
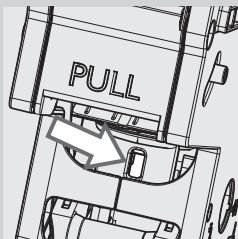

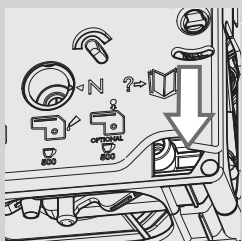
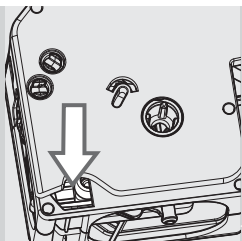

- 3 Lubricate the internal guides positioned on both sides of the brew group.
- 4 Insert the brew group into its seat until it locks into place (see the “Weekly Cleaning of the Brew Group” chapter).
- 5 Insert the drip tray (internal) and the coffee grounds drawer and close the service door.

Monthly Cleaning of the Brew Group with “Coffee Oil Remover”



Besides weekly cleaning, we recommend performing a cleaning cycle with “Coffee Oil Remover” after approximately 500 cups of coffee or once a month. This operation completes the maintenance process for the brew group.

You can purchase the “Coffee Oil Remover” and the “Maintenance Kit” separately. Please refer to the maintenance products page for further details.

Caution:

The “Coffee Oil Remover” tablets are to be used for cleaning only and do not have a descaling function. For the descaling procedure use the Saeco descaling solution and follow the procedure described in the “Descaling” chapter.



- 1 Press the  button to access the machine main menu.

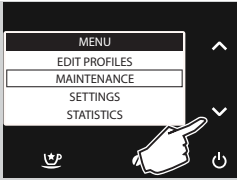

2 Press the “✓” button to select “**MAINTENANCE**”.

3 Press “✓” to confirm.

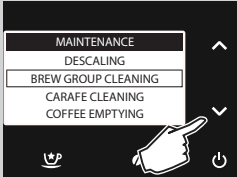

4 Press the “✓” button to select “**BREW GROUP CLEANING**”.

5 Press “✓” to confirm.

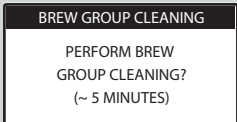

6 Press “✓” to confirm or “↶” to return to the previous menu.

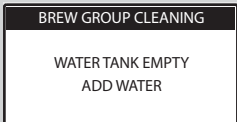

7 Fill the water tank with fresh water up to the MAX level. Press the “✓” button.

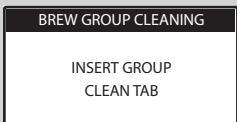

8 Put a “Coffee Oil Remover” tablet in the pre-ground coffee compartment. Press the “✓” button.

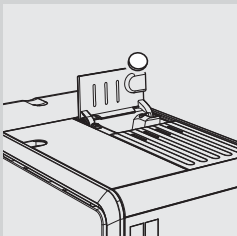

BREW GROUP CLEANING

PLACE A CONTAINER
UNDER THE
DISPENSING SPOUT



- 9** Place a container (1.5 l) under the coffee dispensing spout. Press the “√” button to start the cleaning cycle.



Warning:
Never drink the solution dispensed during this step.

BREW GROUP CLEANING



- 10** This icon is displayed. The display shows the cycle progress.



- 11** When the machine stops dispensing, remove and empty the container.
- 12** Clean the brew group as described in the “Weekly Cleaning of the Brew Group” chapter.

DESCALING

When the "☼☼☼" icon is displayed, you need to descale the machine. The descaling cycle takes approx. 30 minutes.

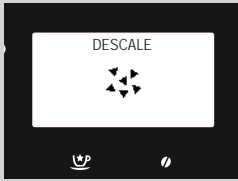

Caution:
Not doing this will ultimately make your machine stop working properly. In this case, repair is NOT covered by warranty.

Warning:
Use the Saeco descaling solution only. Its formula has been designed to ensure better machine performance. The use of other products may damage the machine and leave residues in the water.

The Saeco descaling solution can be purchased separately. For further details, please refer to the maintenance products page in this manual.

Warning:
Never drink the descaling solution or any products dispensed until the cycle has been carried out to the end. Never use vinegar as a descaling solution.

Note:
 Do not remove the brew group during the descaling process.



To perform the descaling cycle, follow the steps below:

1 Press the "☰" button to access the machine main menu.

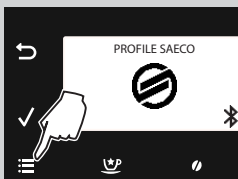

2 Press the "✓" button to select "MAINTENANCE".

3 Press "✓" to confirm.

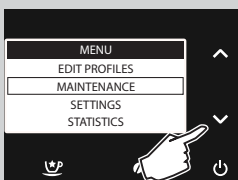

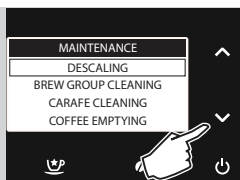

4 Press "☑" to confirm the "DESCALING" selection.



Note:

If the "☑" button is pressed by mistake, press the "↶" button to quit.

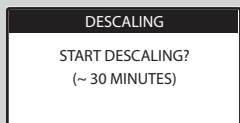

5 Press the "☑" button to confirm.

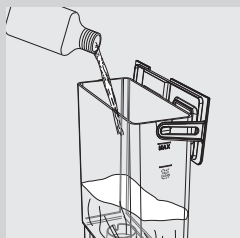
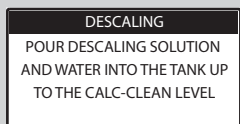

6 Remove the water tank and the "INTENZA+" water filter (if installed) and insert the small white filter supplied with the machine. Pour the entire content of the Saeco descaling solution.

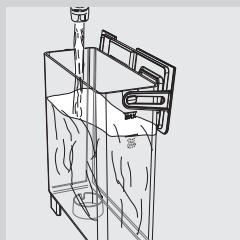

7 Fill the water tank with fresh water up to the CALC CLEAN level. Put the water tank back into the machine. Press the "☑" button.



8 Remove the internal and external drip tray and coffee grounds drawer. Press the "☑" button.

DESCALING

FILL HALF CARAFE
WITH WATER. INSERT
IN BREWING POSITION

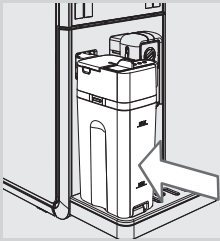

- 9 Fill half the carafe with water and insert it into the machine. Slide the carafe dispenser to the right up to the "☕" icon. Press the "✓" button.

DESCALING

PLACE A CONTAINER
UNDER THE
DISPENSING SPOUT

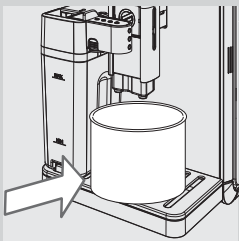

- 10 Place a large container (1.5 l) under both the milk carafe dispenser and the coffee dispensing spout. Press the "✓" button.

DESCALING



- 11 The machine starts dispensing descaling solution at regular intervals. The display shows the cycle progress.

DESCALING



START

- Note:**
to empty the container during the process and to pause the descaling cycle, press the "↶" button. To resume the cycle, press the "✓" button.

RINSING

RINSE WATER TANK &
FILL WITH WATER

- 12 The message indicates the end of the first step. The water tank needs to be rinsed. **Fill the water tank with fresh water up to the MAX level.** Press the "✓" button.

RINSING

EMPTY INTERNAL
DRIP TRAY

- 13** Empty the drip tray (internal) and place it back. Then press the “✓” button.

RINSING

FILL HALF CARAFE
WITH WATER. INSERT
IN BREWING POSITION

- 14** Empty the milk carafe and fill half of it with fresh water. Insert it back into the machine with the dispensing spout open. Press the “✓” button.

RINSING

PLACE A CONTAINER
UNDER THE
DISPENSING SPOUT

- 15** Empty the container and place it back under both the milk carafe dispenser and the coffee dispensing spout. Press the “✓” button.

RINSING



- 16** The rinse cycle starts. The bar shows the progress status of the process.

**Note:**

To empty the container during the process and to pause the rinse cycle, press the “↶” button. To resume the cycle, press the “✓” button.

**Note:**

The rinse cycle is performed in order to have the circuit cleaned with a pre-set amount of water to ensure proper machine performance. If the water tank is not filled up to the MAX level, the machine might require more than one cycle.

- 17** When the amount of water needed for the rinse cycle has been completely dispensed, the machine automatically ends the descaling process.
- 18** At the end of the descaling process, the machine performs an automatic rinse cycle. Wait until it finishes before removing and emptying the container.
- 19** Disassemble and wash the milk carafe as described in the “Weekly Cleaning of the Milk Carafe” chapter.
- 20** Empty the drip tray (internal) and place it back.
- 21** Remove the small white filter and place back the “INTENZA+” water filter into the water tank if it was installed.

**Note:**

At the end of the descaling cycle, wash the brew group as described in the “Weekly Cleaning of the Brew Group” chapter.

ACCIDENTAL INTERRUPTION OF THE DESCALING CYCLE

Once the descaling process has started, it must be completed; do not turn off the machine mid-cycle.

If the descaling process is accidentally interrupted (power failure or accidental disconnection of the power cord), follow the steps below.

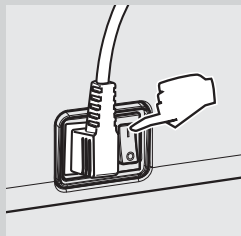

Check that the power button is set to "I".



Press the "⏻" button to turn on the machine.

DESCALING

POUR DESCALING SOLUTION
AND WATER INTO THE TANK UP
TO THE CALC-CLEAN LEVEL









If the cycle was interrupted during the descaling phase, it will be resumed from step 6 of the "Descaling" chapter. Press the "✓" button to restart the cycle.

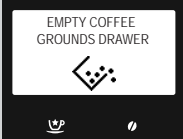

RINSING

RINSE WATER TANK &
FILL WITH WATER

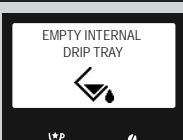
If the cycle was interrupted during the rinse phase, it will be resumed from step 12 of the "Descaling" chapter. Press the "✓" button to restart the cycle.

DISPLAY MESSAGES

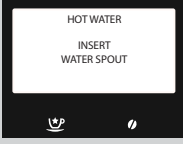
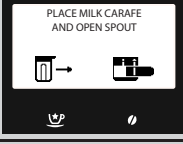
Displayed message	Meaning of the message
	<p>Fill the coffee bean hopper.</p>
	<p>The brew group must be inserted into the machine.</p>
	<p>Insert the coffee grounds drawer and the internal drip tray.</p>
	<p>Empty the coffee grounds drawer.</p> <p> Note: The coffee grounds drawer must be emptied only when the machine requires it and with the machine on. If the drawer is emptied with the machine turned off, the machine will not record the emptying operation.</p>
	<p>Close the service door.</p>
	<p>Remove the water tank and fill it. You can fill the water tank also through the dedicated hole on the lid.</p>
	<p>Open the service door and empty the internal drip tray.</p> <p> Note: If this operation is performed when the machine is on, it will record the coffee grounds drawer emptying and will reset the counter; therefore, you need to empty the coffee grounds as well.</p>
	<p>Insert the coffee bean hopper and/or beans lid.</p>

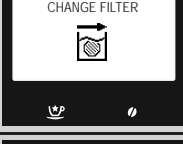
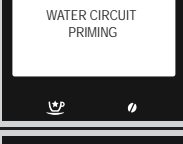
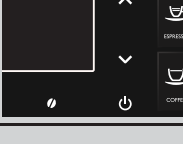
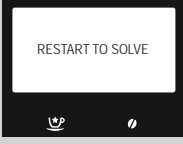
Displayed message	Meaning of the message
	<p>Insert the coffee bean hopper lid and/or beans lid.</p>
	<p>Insert the water dispensing spout to start dispensing. Press "ESC" to exit.</p>
	<p>Before dispensing, insert the milk carafe with the dispensing spout open.</p>
	<p>You need to descale the machine. Follow the steps described in the "Descaling" chapter of this manual. <u>Please note that not descaling your machine will ultimately make it stop working properly. In this case repair is NOT covered under your warranty.</u></p>
	<p>The machine needs the "INTENZA+" water filter to be replaced.</p>
	<p>The machine is priming the water circuit. Wait for this operation to be over.</p>
	<p>The red light flashes. Press any button to exit the stand-by mode.</p>
	<p>Take note of the code (E xx) shown on the display at the bottom. Turn off the machine. Turn it back on after 30 seconds. Repeat the procedure 2 or 3 times. If the machine does not start, contact the Philips SAECO hotline in your country and quote the code shown on the display. Contact details can be found in the warranty booklet packed separately or at www.philips.com/support.</p>

TROUBLESHOOTING

This chapter summarizes the most common problems you could encounter with your machine.

If you are unable to solve the problem with the information below, visit www.saeco.com/support for a list of frequently asked questions or contact the Philips Saeco hotline in your country.

Contact details can be found in the warranty booklet packed separately or at www.saeco.com/support.

Machine actions	Causes	Solutions
The machine does not turn on.	The machine is not connected to the electric network.	Connect the machine to the electric network.
	The power button is on position "0".	Check that the power button is set to "1".
The drip tray gets filled although no water is drained.	Water is sometimes drained automatically by the machine into the drip tray to manage the rinsing of the circuits and ensure optimum machine performance.	This is a normal behaviour of the machine.
Coffee is not hot enough.	The cups/mugs are cold.	Preheat the cups/mugs with hot water or use the hot water dispensing spout.
	The beverage temperature in the programming menu is set on Low.	Make sure that the temperature in the programming menu is set on Normal or High.
	You added cold milk to the coffee.	Cold milk lowers the temperature of the final product. Preheat the milk before adding it to the beverage.
No hot water is dispensed.	The steam/hot water dispensing spout is clogged or dirty.	Clean the hot water dispensing spout. Inspect the steam spout to check that the dispensing spout is not clogged. Make a hole in the limescale using a pin or a needle.
The machine does not fill the cup/mug.	The machine has not been programmed.	Access the beverage programming menu and adjust the coffee length setting according to your personal taste for each type of beverage.
Coffee does not have enough crema (see note).	The blend is unsuitable, coffee is not freshly roasted or the grind is too coarse.	Change coffee blend or adjust grinding as explained in the "Adjusting the Ceramic Coffee Grinder" chapter.
	The coffee beans or the pre-ground coffee are too old.	Make sure that you use fresh coffee beans or pre-ground coffee.
Milk does not froth.	The milk dispensing spout has not been pulled out	Check that the milk dispensing spout has been pulled out correctly up to the "  " icon
	The carafe has not been correctly reassembled or with all its components.	Make sure the tube is correctly inserted. All its components have to be correctly reassembled, as described in the "Weekly cleaning of the Milk Carafe" section.

Machine actions	Causes	Solutions
The machine takes a long time to warm up or the amount of water dispensed from the wand is too little.	The machine circuit is clogged by limescale.	Descale the machine.
The brew group cannot be removed.	The brew group is out of place.	Turn on the machine. Close the service door. The brew group automatically returns to the initial position.
	The coffee grounds drawer is inserted.	Remove the coffee grounds drawer before removing the brew group.
There is too much ground coffee under or over the brew group.	The coffee used may not be suitable for automatic machines.	It may be necessary to change the type of coffee or the coffee grinder settings (see the "Adjusting the Ceramic Coffee Grinder" chapter).
	The machine is adjusting the coffee grinder for a new kind of coffee beans or pre-ground coffee.	The machine automatically adjusts itself after brewing several cups of coffee to optimise the extraction in relation to the compactness of the ground coffee. It may be necessary to brew 2 or 3 products to adjust the coffee grinder completely. This is not a malfunction of the machine.
The machine produces too humid or too dry coffee grounds.	Adjust the coffee grinder.	Adjusting the ceramic coffee grinder affects the quality of residues. If the residues are too humid, set a coarser grind. If the residues are too dry, set a finer grind. Refer to the "Adjusting the Ceramic Coffee Grinder" chapter.
The machine grinds coffee beans but no coffee comes out. (see note).	There is no water.	Fill the water tank and prime the circuit (see the "Manual Rinse Cycle" chapter).
	The brew group is dirty.	Clean the brew group (see the "Weekly Cleaning of the Brew Group" chapter).
	This might occur when the machine is automatically adjusting the dose.	Brew some cups of coffee as described in the "Saeco Adapting System" chapter.
Coffee is too weak (see note).	The dispensing spout is dirty.	Clean the dispensing spout.
	This might occur when the machine is automatically adjusting the dose.	Brew some cups of coffee as described in the "Saeco Adapting System" chapter.
	The ground coffee is too coarse.	Change coffee blend or adjust grinding as explained in the "Adjusting the Ceramic Coffee Grinder" chapter.
	The coffee bean hopper selector switch has been shifted.	Move the selector switch to the  position.

Machine actions	Causes	Solutions
Coffee is brewed slowly (see note).	The ground coffee is too fine.	Change coffee blend or adjust grinding as explained in the "Adjusting the Ceramic Coffee Grinder" chapter.
	Circuits clogged.	Perform a descaling cycle.
	The brew group is dirty.	Clean the brew group (see the "Weekly Cleaning of the Brew Group" chapter).
Coffee leaks out of the dispensing spout.	The dispensing spout is clogged or not correctly inserted.	Clean the dispensing spout and its holes and insert it back correctly.
The dispenser cannot be installed on the milk carafe.	The pin is in the wrong position.	Manually push the pin to the correct position and insert the carafe dispenser.
The machine does not connect to the application.	The mobile device is too far away from the machine.	Do not step more than 5 metres away from the machine while using the mobile device.

**Note:**

These problems can be considered normal if the coffee blend has been changed or if the machine has just been installed. In this case wait until the machine performs a self-adjusting operation as described in the "Saeco Adapting System" chapter.

ENERGY SAVING

Stand-by

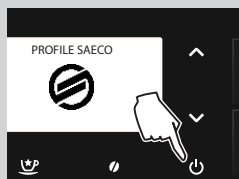
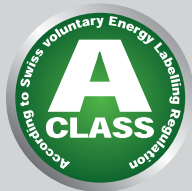

The Saeco fully automatic espresso coffee machine is designed for energy saving, as proven by the Class A energy label.

After a certain time of inactivity that can be set by the user (see the “Machine Programming” chapter), the machine turns off automatically. If a product has been brewed, the machine performs a rinse cycle. In stand-by mode, the energy consumption is below 1Wh.

To turn on the machine, press the “” button for a few seconds (if the power button on the back of the machine is set to “I”). If the boiler is cold, the machine performs a rinse cycle.

The machine status can be manually changed to stand-by mode by holding the STAND-BY button for 3 seconds.

**Note:**

- 1 The stand-by mode cannot be activated if the service door is left open.
- 2 When the stand-by mode is activated, the machine may perform a rinse cycle. The cycle can be interrupted by pressing the “” button.

The machine can be reactivated again by:

- 1 Pressing any button on the control panel.
- 2 Opening the service door (when closing the door the machine goes back to stand-by mode).

The red indicator light on the “” button flashes when the machine is in stand-by mode.

Disposal



Do not throw away the machine with the normal household waste at the end of its life, but hand it in at an official collection point for recycling. By doing this, you help to preserve the environment.

- Packaging materials can be recycled.
- Machine: unplug the machine and cut the power cord.
- Deliver the appliance and power cord to a service centre or public waste disposal facility.

This product complies with EU Directive 2002/96/EC.

The symbol on the product or on its packaging indicates that this product cannot be treated as household waste. Instead, it shall be handed over to the applicable collection point for the recycling of electrical and electronic equipment.

By ensuring this product is disposed of correctly, you will help prevent potential negative consequences for the environment and human health, which could otherwise be caused by inappropriate waste handling of this product. For more detailed information about recycling this product, please contact your local city office, your household waste disposal service or the shop where you purchased the product.

TECHNICAL SPECIFICATIONS

The manufacturer reserves the right to make changes to the technical specifications of the product.

Nominal Voltage - Power Rating - Power Supply	See data plate on the appliance
Housing material	Thermoplastic Material/Metal
Size (w x h x d)	210 x 360 x 460 mm
Weight	13 kg
Power cord length	800-1200mm
Control panel	Front panel
Cup size	110 mm
Water tank	1.7 litres - Removable type
Coffee bean hopper capacity	270 g
Coffee grounds drawer capacity	20
Pump pressure	15 bar
Boiler	Stainless Steel
Safety devices	Boiler pressure safety valve - Double safety thermostat - Thermal fuse
Bluetooth	Bluetooth Smart (low energy)
Maximum use distance	5 m
Tablet compatibility	Avanti App is compatible with iPad 3/4/Air/mini retina, running iOS7 and newer; with Samsung Galaxy Tab 3 (8.0")/Tab 4 (10.1")/Note pro LTE (12.2"), Nexus 7 2013 (7"), Sony Xperia Z LTE (10.1"), running Android v.4.3 and newer, and Bluetooth version 4.0 and newer.

WARRANTY AND SERVICE

Warranty

For detailed information on your warranty and related conditions, please read the warranty booklet supplied separately.

Service

We want to ensure that you remain satisfied with your machine. If you have not already done so, please register your purchase at **www.saeco.com/welcome**. This will enable us to stay in contact with you and send you cleaning and descaling reminders.

If you need service or support, please visit the Philips website at **www.saeco.com/support** or contact the Philips Saeco hotline in your country. Contact details can be found in the warranty booklet supplied separately or at **www.saeco.com/support**.

ORDERING MAINTENANCE PRODUCTS

For cleaning and descaling, use Saeco maintenance products only. You can purchase these products at the Philips online shop (if available in your country) at www.shop.philips.com/service, from your local dealer or at authorised service centres.

If you have any difficulties obtaining maintenance products for your machine, please contact the Philips Saeco hotline in your country.

Contact details can be found in the warranty booklet packed separately or at www.saeco.com/support.

Overview of maintenance products

- Descaling solution CA6700



- INTENZA+ Water Filter CA6702



- Grease HD5061





- Coffee Oil Remover CA6704



- Milk Circuit Cleaner CA6705







- Maintenance Kit CA 6706

MACHINE ACCESSORIES



- Removable coffee bean hopper CA6807

Name	Display Icon	Approx. Coffee Length	Approx. Milk Length
Espresso		ITA: 40 ml DAC:50 ml Range 30-70 ml	
Espresso Lungo		Default: 70 ml Range: 40-110 ml	
Coffee		Default: 110ml Range: 70-140 ml	
American Coffee		Default: 170 ml Range 110-320 ml	
Espresso Macchiato		ITA: 40 ml DAC:50 ml Range 30-70 ml	Default: 5 sec Range 5-30 sec
Cappuccino		ITA: 40 ml DAC: 70 ml Range 30-170 ml	Default: 20 sec Range 10-50 sec
Latte Macchiato		ITA: 70 ml DAC: 110 ml Range 30-170 ml	Default: 25 sec Range 10-75 sec
Frothed milk			Default: 30 sec Range: 10-75 sec

Name	Display Icon	Approx. Coffee Length	Approx. Milk Length
Ristretto		Default: 30 ml Range: 20-40ml	
Espresso Intense		Default: 70 ml Range: 40-110 ml	
Espresso Mild		ITA: 40 ml DAC:50 ml Range 30-70 ml	
Energy Coffee		Default: 170 ml Range 110-320 ml	
Flat White (Café au lait)		ITA: 70 ml DAC:110 ml Range 30-260 ml	Default: 20 sec Range 10-50 sec
Hot Water		Default: 300 ml Range 50-450 ml	



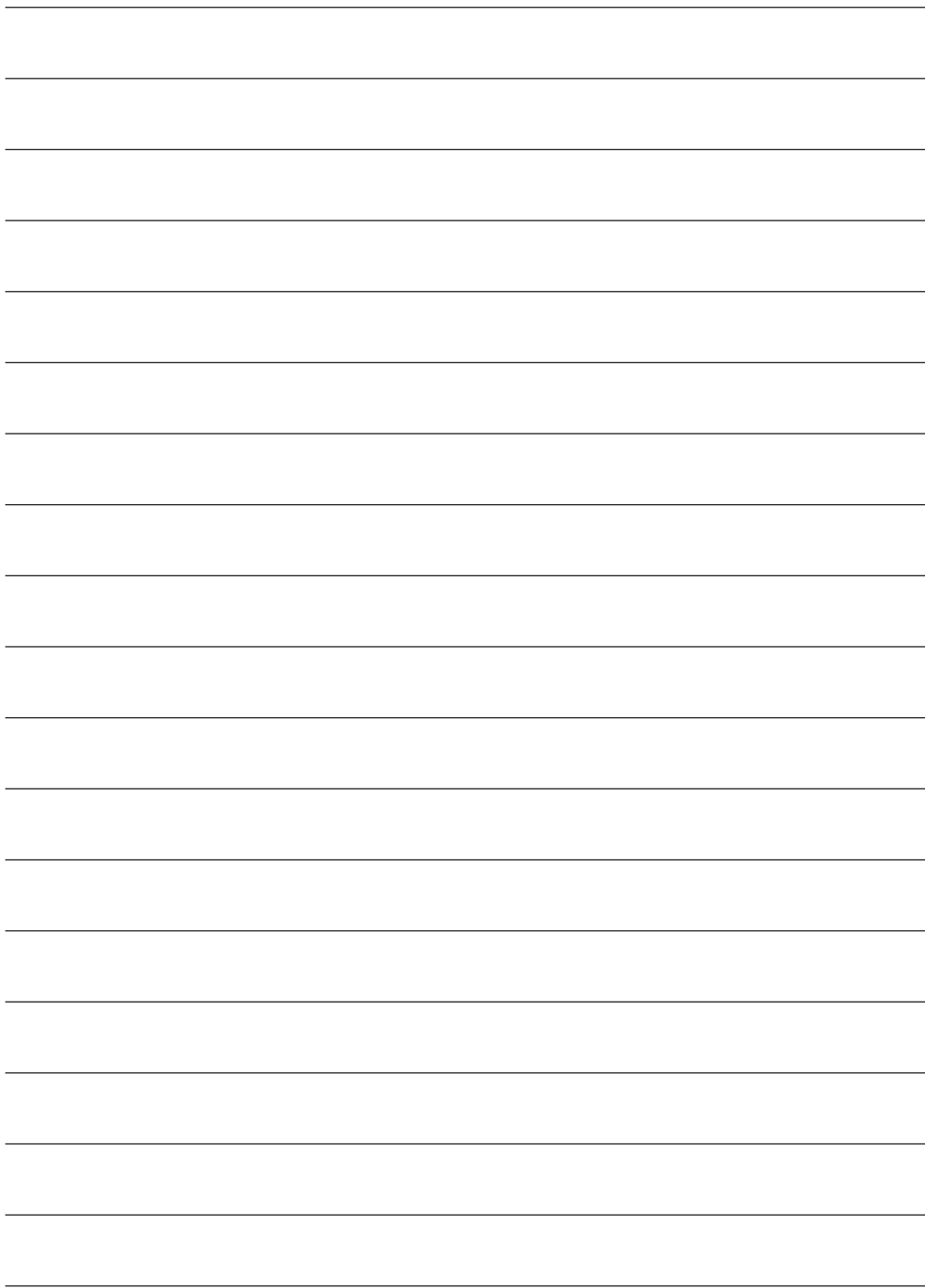



421946017741

EN

02

The manufacturer reserves the right to make changes without prior notice.



www.philips.com/saeco