

Super automatic espresso coffee machine
3100 series

02

USER MANUAL

HD8826
HD8831

English

Read carefully before using the machine.



EN

02

CE

Register your product and get support at
www.philips.com/welcome

PHILIPS

IMPORTANT SAFEGUARDS

When using electrical appliances, basic safety precautions should always be followed, including the following:

1. Read all instructions.
2. Do not touch hot surfaces. Use handles or knobs.
3. To protect against fire, electric shock and injury to persons do not immerse cord, plugs, or appliance in water or other liquid.
4. Close supervision is necessary when the appliance is used by or near children.
5. Unplug from outlet when not in use and before cleaning. Allow to cool before putting on or taking off parts, and before cleaning the appliance.
6. Do not operate any appliance with a damaged cord or plug or after the appliance malfunctions, or has been damaged in any manner. Return appliance to the nearest authorized service facility for examination, repair or adjustment.
7. The use of accessory attachments not recommended by the appliance manufacturer may result in fire, electric shock or injury to persons.
8. Do not use outdoors.
9. Do not let cord hang over edge of table or counter, or touch hot surfaces.
10. Do not place on or near a hot gas or electric burner, or in a heated oven.
11. Always attach plug to appliance first, then plug cord into wall outlet. To disconnect, turn any control to "off", then remove plug from wall outlet.
12. Do not use appliance for other than intended use.
13. Save these instructions.

SAVE THESE INSTRUCTIONS

CAUTION

This appliance is for household use only. Any servicing, other than cleaning and user maintenance, should be performed by an authorized service center. Do not immerse machine in water. To reduce the risk of fire or electric shock, do not disassemble the machine. There are no parts inside the machine serviceable by the user. Repair should be done by authorized service personnel only.

1. Check voltage to be sure that the voltage indicated on the nameplate corresponds with your voltage.
2. Never use warm or hot water to fill the water tank. Use cold water only.
3. Keep your hands and the cord away from hot parts of the appliance during operation.
4. Never clean with scrubbing powders or harsh cleaners. Simply use a soft cloth dampened with water.
5. For optimal taste of your coffee, use purified or bottled water. Periodic descaling is still recommended every 2-3 months.
6. Do not use caramelized or flavored coffee beans.

INSTRUCTIONS FOR THE POWER SUPPLY CORD

- A. A short power-supply cord (or detachable power-supply cord) is to be provided to reduce risks resulting from becoming entangled in or tripping over a longer cord.
- B. Longer detachable power-supply cords or extension cords are available and may be used if care is exercised in their use.
- C. If a long detachable power-supply cord or extension cord is used,
 1. The marked electrical rating of the detachable power-supply cord or extension cord should be at least as great as the electrical rating of the appliance
 2. If the appliance is of the grounded type, the extension cord should be a grounding-type 3-wire cord, and
 3. The longer cord should be arranged so that it will not drape over the counter top or table top where it can be pulled on by children or tripped over.

Congratulations on your purchase of a Philips super automatic espresso coffee machine with Classic Milk Frother! To fully benefit from the support that Philips offers, register your product at www.philips.com/welcome. The machine is made for preparing espresso coffee using whole coffee beans and for dispensing steam and hot water. In this user manual you will find all the information you need to install, use, clean and descale your machine.

CONTENTS

IMPORTANT	4
Safety Instructions.....	4
Warnings.....	4
Cautions.....	6
Electromagnetic Fields.....	7
Disposal.....	7
INSTALLATION	8
Product Overview.....	8
General Description.....	9
PREPARING FOR USE	10
Machine Packaging.....	10
Machine Installation.....	10
USING THE MACHINE FOR THE FIRST TIME	13
Circuit Priming.....	13
Automatic Rinse/Self-Cleaning Cycle.....	14
Manual Rinse Cycle.....	14
MEASURING AND PROGRAMMING WATER HARDNESS	16
"INTENZA+" WATER FILTER	18
"INTENZA+" Water Filter Installation.....	18
Replacing the "INTENZA+" Water Filter.....	20
ADJUSTMENTS	21
Saeco Adapting System.....	21
Adjusting the Ceramic Coffee Grinder.....	21

Adjusting the Aroma (Coffee Strength)	22
Adjusting the Dispensing Spout	23
Adjusting the Coffee Length	24
BREWING ESPRESSO AND LONG ESPRESSO	25
Brewing Espresso or Long Espresso Using Coffee Beans	25
Brewing Espresso or Long Espresso Using Pre-Ground Coffee	26
DISPENSING STEAM / BREWING CAPPUCCINO	27
HOT WATER DISPENSING	28
CLEANING AND MAINTENANCE	29
Daily Cleaning of the Machine	29
Cleaning of the Water Tank	30
Daily Cleaning of the Classic Milk Frother	31
Weekly Cleaning of the Machine	31
Weekly Cleaning of the Classic Milk Frother	31
Weekly Cleaning of the Brew Group	32
Monthly Lubrication of the Brew Group	36
Monthly Cleaning of the Brew Group with "Coffee Oil Remover"	37
Monthly Cleaning of the Coffee Bean Hopper	39
DESCALING	40
Preparation Phase	40
Descaling Phase	42
Rinse Phase	43
Interruption of the Descaling Cycle	45
PROGRAMMING	46
The Following Settings Can Be Adjusted	46
How to Program the Machine	47
MEANING OF THE DISPLAY ICONS	49
TROUBLESHOOTING	53
ENERGY SAVING	56
Stand-by	56
TECHNICAL SPECIFICATIONS	56
FACTORY SETTINGS	57
WARRANTY AND SERVICE	57
Warranty	57
Service	57
ORDERING MAINTENANCE PRODUCTS	58

IMPORTANT

Safety Instructions

This machine is equipped with safety devices. Nevertheless, read and follow the safety instructions carefully and only use the machine properly as described in these instructions to avoid accidental injury or damage due to improper use of the machine. Keep this user manual for future reference.



The term **WARNING** and this icon warn against possible severe injuries, danger to life and/or damage to the machine.



The term **CAUTION** and this icon warn against slight injuries and/or damage to the machine.

Warnings

- Connect the machine to a wall socket with a voltage matching the technical specifications of the machine.
- Connect the machine to an earthed wall socket.
- Do not let the power cord hang over the edge of a table or counter, or touch hot surfaces.
- Never immerse the machine, the mains plug or power cord in water: Danger of electrical shock!
- Do not pour liquids on the power cord connector.
- Never direct the hot water jet towards body parts: Danger of burning!
- Do not touch hot surfaces. Use handles and knobs.
- After switching off the machine by pressing the power button on the back of the machine, remove the mains plug from the wall socket:
 - if a malfunction occurs;
 - If the machine will not be used for a long time;

- before cleaning the machine.
- Pull on the mains plug, not on the power cord.
- Do not touch the mains plug with wet hands.
- Do not use the machine if the mains plug, the power cord or the machine itself is damaged.
- Do not make any modifications to the machine or its power cord. Only have repairs carried out by a service centre authorised by Philips to avoid any hazard.
- The machine should not be used by children younger than 8 years old.
- The machine can be used by children of 8 years and upwards if they have previously been instructed on the correct use of the machine and made aware of the associated dangers or if they are supervised by an adult.
- Cleaning and maintenance should not be carried out by children unless they are more than 8 years old and supervised by an adult.
- Keep the machine and its power cord out of reach of children under 8 years old.
- The machine may be used by persons with reduced physical, sensory or mental capabilities or lacking sufficient experience and/or skills if they have previously been instructed on the correct use of the machine and made aware of the associated dangers or if they are supervised by an adult.
- Children should be supervised to ensure that they do not play with the machine.
- Never insert fingers or other objects into the coffee grinder.

Cautions

- The machine is for household use only. It is not intended for use in environments such as canteens, staff kitchens of shops, offices, factories or other work environments.
- Always put the machine on a flat and stable surface.
- Do not place the machine on hot surfaces, directly next to a hot oven, heater units or similar sources of heat.
- Only put roasted coffee beans into the coffee bean hopper. If ground coffee, instant coffee, raw coffee or any other substance is put in the coffee bean hopper, it may damage the machine.
- Let the machine cool down before inserting or removing any parts. The heating surfaces may retain residual heat after use.
- Never use warm or hot water to fill the water tank. Use only cold non-sparkling drinking water.
- Never clean with scrubbing powders or harsh cleaners. Simply use a soft cloth dampened with water.
- Descale your machine regularly. Not doing this will make your appliance stop working properly. In this case, repair is not covered under your warranty!
- Do not keep the machine at temperature below 0 °C. Residue water in the heating system may freeze and cause damage.
- Do not leave water in the water tank if the machine is not used over a long period of time. The water can get contaminated. Use fresh water every time you use the machine.

Electromagnetic Fields

This appliance complies with all the applicable standards and regulations relating to the exposure to electromagnetic fields.

Disposal



This symbol on a product indicates that the product is covered by EU Directive 2012/19/EU. Please inform yourself about the local separate collection system for electrical and electronic products. Follow local regulations and do not dispose of the product as household waste. Appropriate disposal of old products helps prevent negative consequences for the environment and human health.

INSTALLATION

Product Overview

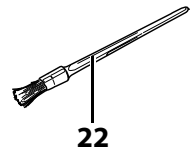
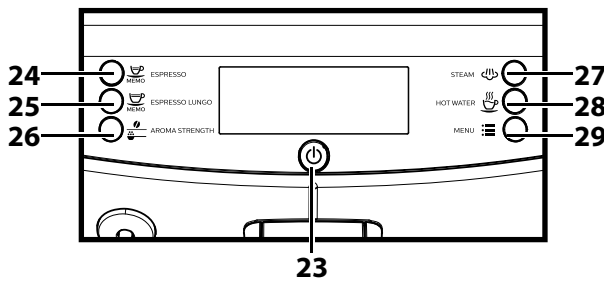
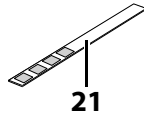
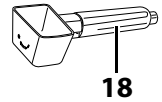
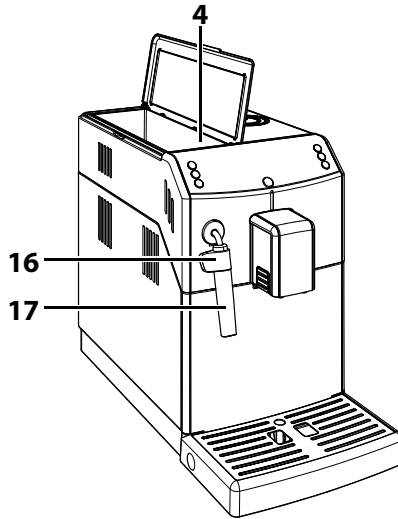
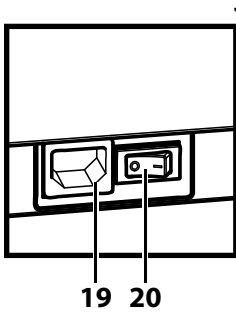
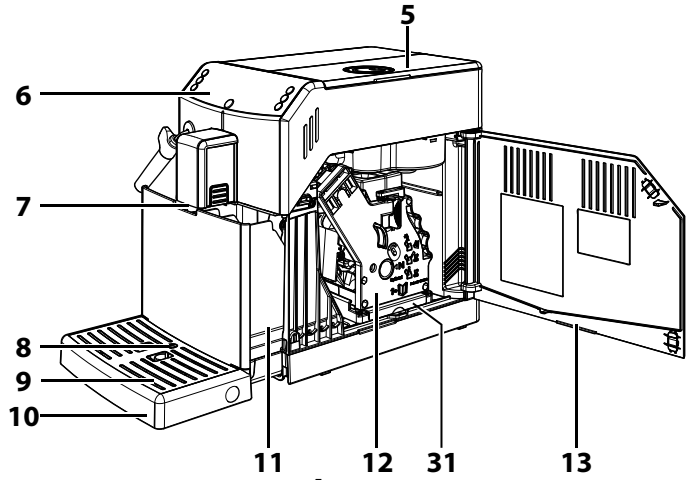
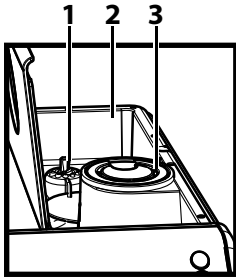

General Description

1. Grinder adjustment knob
2. Coffee bean hopper
3. Pre-ground coffee compartment
4. Water tank + Lid
5. Coffee bean hopper lid
6. Control panel
7. Coffee dispensing spout
8. Full drip tray indicator
9. Cup holder grill
10. Drip tray
11. Coffee grounds drawer
12. Brew group
13. Service door
14. Grease for brew group - (optional)
15. Power cord
16. Wand protective gripper
17. Classic Milk Frother (for hot water/steam)
18. Coffee grinder adjustment key + Pre-ground coffee measuring scoop +
Coffee outlet duct cleaning tool
19. Power cord socket
20. Power button
21. Water hardness test strip
22. Cleaning brush - (optional)
23. ON/OFF button
24. Espresso brew button
25. Long espresso brew button
26. "Aroma" - Pre-ground coffee button
27. Steam button
28. Hot water button
29. Descaling button
30. Descaling solution - to be purchased separately
31. Coffee residues drawer

PREPARING FOR USE

Machine Packaging

The original packaging has been designed and constructed to protect the machine during transport. We recommend keeping the packaging material for possible future transport.

Machine Installation

1 Remove the machine from the packaging.

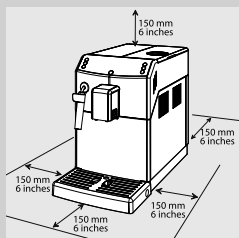

2 For best use, it is recommended to:

- Choose a safe, level surface where there will be no danger of overturning the machine or being injured.
- Choose a location that is sufficiently well-lit, clean and near an easily reachable socket.
- Allow for a minimum distance from the sides of the machine as shown in the figure.

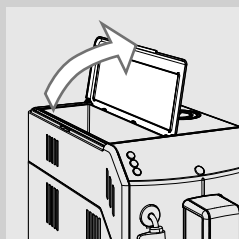

3 Open the water tank lid.

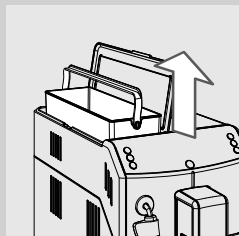

4 Remove the water tank by using the handle.

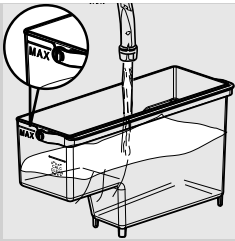

5 Rinse the water tank with fresh water.

6 Fill the water tank with fresh water up to the MAX level and reinsert it into the machine. Make sure it is fully inserted.



Caution:

Never fill the water tank with warm, hot, sparkling water or any other liquid, as this may cause damage to the water tank and the machine.

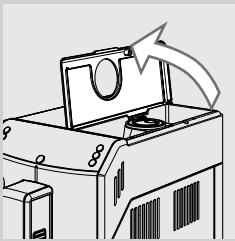

7 Lift the coffee bean hopper lid.

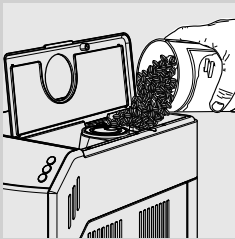

8 Slowly pour the coffee beans into the coffee bean hopper.



Note:

Do not pour too many coffee beans into the coffee bean hopper as this will reduce the grinding performance of the machine.



Caution:

Only coffee beans must be put into the coffee bean hopper. If ground coffee, instant coffee, caramelized coffee, raw coffee beans or any other substance is put in the coffee bean hopper, it may damage the machine.

9 Put the lid back on the coffee bean hopper.

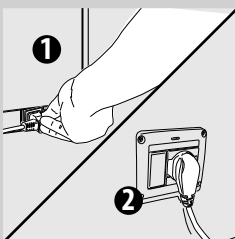

10 Insert the plug into the socket located on the back of the machine.

11 Insert the plug at the other end of the power cord into a wall socket with suitable power voltage.

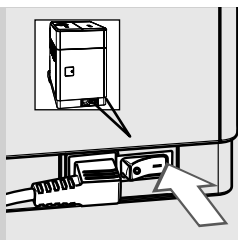

12 Switch the power button to "I". The "⏻" button flashes.

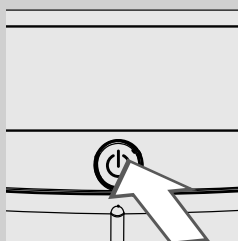

13 Press the "⏻" button to turn on the machine.

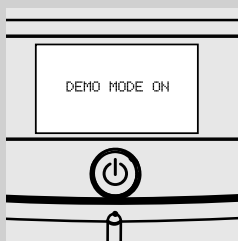

Note:

By keeping the "⏻" button pressed for more than 8 seconds, the machine enters the demo mode. To exit the demo, turn the machine off and on again using the power button.

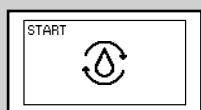

Yellow

14 The control panel indicates that the circuit must be primed.

USING THE MACHINE FOR THE FIRST TIME

When using the machine for the first time, the following activities need to happen:

- 1) You need to prime the circuit.
- 2) The machine will perform an automatic rinse/self-cleaning cycle.
- 3) You need to perform a manual rinse cycle.

Circuit Priming

During this process, fresh water flows through the internal circuit of the machine and the machine warms up. This takes a few minutes.



- 1 Place a container under the Classic Milk Frother.

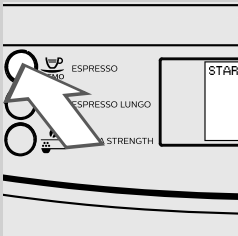

- 2 Press the "MEMO" button to start the circuit priming cycle.



Yellow

- 3 The bar under the icon shows the operation progress. When the process has been completed, the machine stops dispensing automatically.

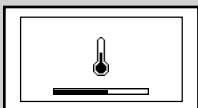

Yellow

- 4 The control panel now shows the machine warm-up icon.

Automatic Rinse/Self-Cleaning Cycle

When warm-up has been completed, the machine automatically performs a rinse/self-cleaning cycle of the internal circuits with fresh water. This takes less than a minute.

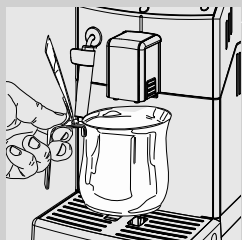

- Place a container under the coffee dispensing spout to catch the small amount of water which will be dispensed.



Yellow

- The machine performs an automatic rinse cycle. Wait for the cycle to finish automatically.



Note:

Dispensing can be stopped by pressing the "MEMO" button.

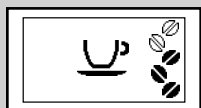

Green

- When the operations described above have been completed, the machine shows this display. You can now perform the manual rinse cycle.

Manual Rinse Cycle

During this process, the coffee brewing cycle is activated and fresh water flows through the water circuit. This takes a few minutes.

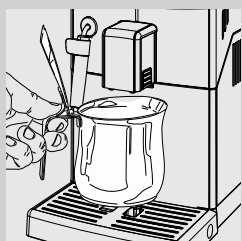

- Place a container under the coffee dispensing spout.

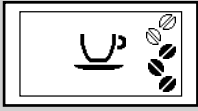

Green

2 Check that the machine shows this display.



Green

3 To select the pre-ground coffee brewing function, press the “” button until this display is shown.



Note:

Do not add any pre-ground coffee into the compartment.

4 Press the “” button. The machine will start dispensing water from the coffee dispensing spout.

5 When dispensing has finished, empty the container. Repeat the operations from step 1 to step 4 twice, then continue with step 6.

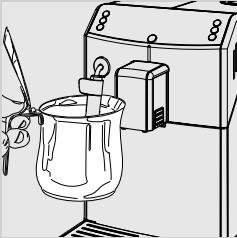

6 Place a container under the Classic Milk Frother.

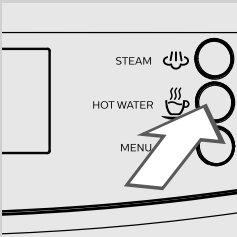

7 Press the “” button to start dispensing hot water.

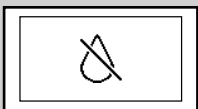

Red

8 Dispense water until the no water icon appears.



Note:

The manual rinse cycle can be stopped by pressing the “” button.

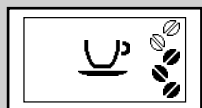
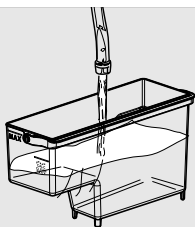

Green

- 9** At the end of this operation, fill the water tank again up to the MAX level. Now the machine is ready to brew coffee. The display on the left will be shown.

Note:

The automatic rinse/self-cleaning cycle starts when the machine has been in stand-by mode, or turned off, for more than 15 minutes. When you have not used the machine for 2 or more weeks, you will need to perform a manual rinse cycle. At the end of the cycle, you can brew a coffee.

MEASURING AND PROGRAMMING WATER HARDNESS

Water hardness measuring is very important in order to define the descaling frequency and to install the "INTENZA+" water filter (for more details on the water filter, see next chapter).

To measure water hardness, follow the steps below:

- 1** Immerse the water hardness test strip (supplied with the machine) in water for 1 second.

Note:

The test strip can only be used for one single measurement.

- 2** Wait for one minute.

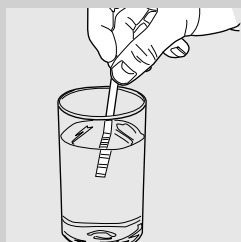

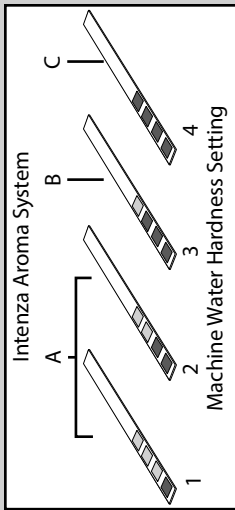

- 3 Check how many squares have changed colour to red and then refer to the table.

 **Note:**



The numbers on the water hardness test strip correspond to the water hardness adjustment settings.

- More precisely:
 1 = 1 (very soft water)
 2 = 2 (soft water)
 3 = 3 (hard water)
 4 = 4 (very hard water)

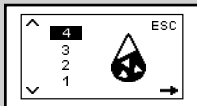
The letters correspond to the references that are located at the base of the "INTENZA+" water filter (see next chapter).



Yellow



- 4 Press the "" button and scroll through the options by pressing the "" button until this icon is displayed.

 **Note:**

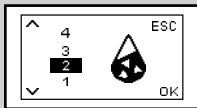
The machine is supplied with a standard water hardness setting, suitable for most types of water.



Yellow

- 5 Press the "" button to increase the value and the "" button to decrease the value.

- 6 Press the "" button to confirm the setting.

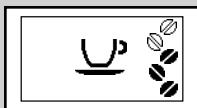

Green

- 7 Press the "" button to exit the programming MENU. The machine shows this display and is ready for brewing.

"INTENZA+" WATER FILTER

We recommend you to install the "INTENZA+" water filter as this prevents limescale build-up in your machine and preserves a more intense aroma of your coffee.



The "INTENZA+" water filter can be purchased separately. For further details, please refer to the maintenance products page in this user manual. Water is a crucial part of every coffee, so it is very important to always have it professionally filtered. Using the "INTENZA+" water filter will prevent mineral deposits from building up and improve your water quality.

"INTENZA+" Water Filter Installation

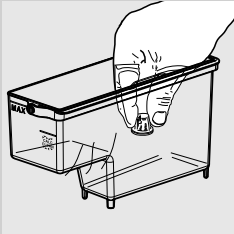

- 1 Remove the small white filter from the water tank and store it in a dry place.

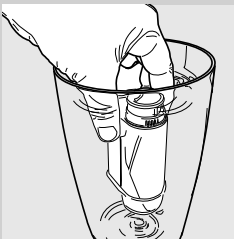

- 2 Remove the "INTENZA+" water filter from its packaging, immerse it vertically (with the opening positioned upwards) in cold water and gently press the sides so as to let the air bubbles out.

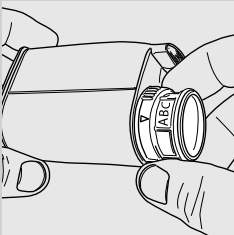

- 3 Set the "INTENZA+" water filter according to the measurements performed (see previous chapter) and indicated on the base of the filter:
 A = soft water – equals 1 or 2 on the test strip
 B = hard water (standard) – equals 3 on the test strip
 C = very hard water – equals 4 on the test strip

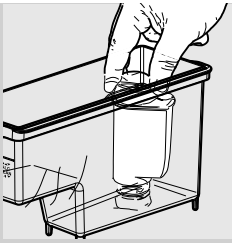

4 Put the "INTENZA+" water filter into the empty water tank. Press it down until it cannot move any further.

5 Fill the water tank with fresh water and put it into the machine.

6 Dispense all the water in the water tank by using the hot water function (see the "Hot Water Dispensing" chapter).

7 Fill the water tank again.

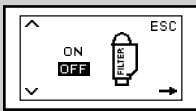

Yellow

8 Press the "☰" button and scroll the options by pressing the "☷" button until this display is shown.

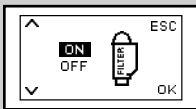

Yellow

9 Press the "☺" button to select "ON" and press the "☷" button to confirm.

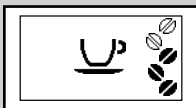

Green

10 Press the "☺" button to exit. The machine shows this display and is ready for brewing.

The machine has now been programmed to inform the user of the need to replace the "INTENZA+" water filter.

Replacing the "INTENZA+" Water Filter

When the "INTENZA+" water filter needs to be replaced with a new one, this icon is displayed.

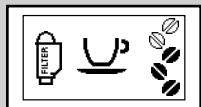

Yellow

- 1 Replace the "INTENZA+" water filter as described in the previous chapter.



Yellow

- 2 Press the "☰" button and scroll through the options by pressing the "☷" button until this icon is displayed.



Yellow

- 3 Select the "RESET" option. Press the "☷" button to confirm.

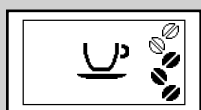

Green

- 4 Press the "☰" button to exit. The machine shows this display and is ready for brewing.

The machine is now programmed to manage a new "INTENZA+" water filter.

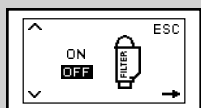

Yellow

Note:

If the "INTENZA+" water filter is already installed and you want to remove, but not replace it, select the "OFF" option instead.

If there is no "INTENZA+" water filter installed, insert the small white filter previously removed into the water tank.

ADJUSTMENTS

The machine allows for certain adjustments so that you can enhance the quality and taste of your coffee.

Saeco Adapting System

Coffee is a natural product and its characteristics may change according to its origin, blend and roast. The machine is equipped with a self-adjusting system that allows the use of all types of coffee beans available on the market, except for raw, caramelized and flavoured coffee beans.

The machine automatically adjusts itself after brewing a certain number of cups of coffee to optimise extraction.

Adjusting the Ceramic Coffee Grinder

Ceramic coffee grinders always guarantee accurate and perfect grinding and coarseness for every coffee speciality.

This technology provides full aroma preservation, delivering a truly Italian taste in every cup.



Warning:

The ceramic coffee grinder contains moving parts that may be dangerous. Do not insert fingers or other objects. Only adjust the ceramic coffee grinder using the grinder adjustment key.

You can adjust the ceramic grinders to set coffee grinding to your personal taste.



Warning:

You can only adjust the coffee grinder settings when the machine is grinding coffee beans.

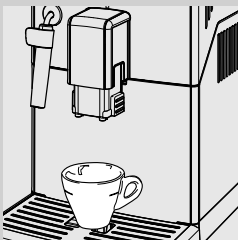

1

Place a cup under the dispensing spout.
Press the "MEMO" button to brew an espresso.

Adjusting the Dispensing Spout

The height of the dispensing spout can be adjusted to better fit the dimensions of the cups that you wish to use.

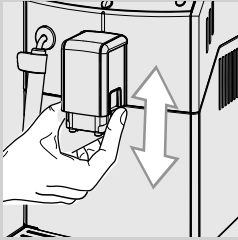

Move the dispensing spout up or down with your fingers to adjust its height as shown in the figure.



The recommended positions are:
For the use of small cups;



For the use of large cups.

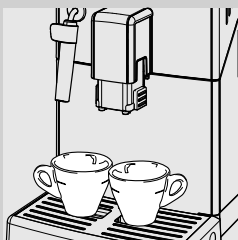

Two cups can also be placed under the dispensing spout to brew two cups of espresso or long espresso at the same time.

Adjusting the Coffee Length

The machine allows you to adjust the amount of brewed coffee according to your taste and the size of your cups.

Each time the “MEMO” or “MEMO” button is pressed, the machine brews a pre-set amount of coffee. Each button may be individually programmed for a specific brew setting.

The following procedure describes how to program the “MEMO” button.

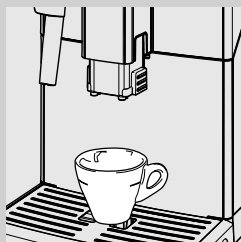

- 1 Place a cup under the dispensing spout.



Green

- 2 Keep the “MEMO” button pressed until the “MEMO” icon appears on the display to program an espresso, or do the same with the “MEMO” button to program a long espresso. Then release the button. The machine is in programming mode and starts brewing the selected product.

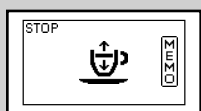

Green

- 3 Press the “MEMO” button as soon as the desired amount of coffee is reached.

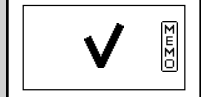

Green

The previously selected “MEMO” or “MEMO” button is now programmed; each time it is pressed, the machine will brew the same amount of espresso or coffee that was just programmed.

BREWING ESPRESSO AND LONG ESPRESSO

Before brewing coffee, make sure that there are no warnings shown on the control panel, and that the water tank and coffee bean hopper are filled.

Brewing Espresso or Long Espresso Using Coffee Beans

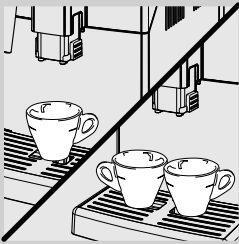



1 Place 1 or 2 cups under the dispensing spout.

2 To brew an espresso or a long espresso, press the “” button to select the desired aroma.



Green

3 Press the “” button for an espresso or the “” button for a long espresso.

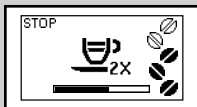

Green

4 To brew two cups of espresso or long espresso, press the desired button twice consecutively. This icon will be displayed.

Note:

In this operating mode, the machine automatically grinds and doses the correct amount of coffee. Brewing two cups of espresso or long espresso requires two grinding and brewing cycles, automatically carried out by the machine.

5 After the prebrewing cycle, coffee begins to pour out of the dispensing spout.

6 Coffee brewing stops automatically when the set level is reached; however, you can stop it earlier by pressing the “” button.

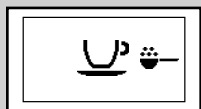

Green

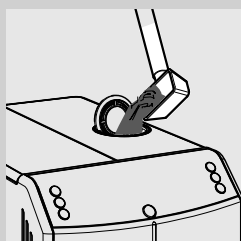

Brewing Espresso or Long Espresso Using Pre-Ground Coffee

This function allows you to use pre-ground coffee. With the pre-ground coffee function you can only brew one coffee at a time.

- 1 Press the “☕” button one or more times to select the pre-ground coffee function.

- 2 Lift the pre-ground coffee compartment lid and add one level measuring scoop of pre-ground coffee. Use only the measuring scoop supplied with the machine. Then close the pre-ground coffee compartment lid.



Warning:

Add only pre-ground coffee to the pre-ground coffee compartment. Other substances and objects may cause severe damage to the machine. Such damage will not be covered by warranty.

- 3 Press the “☕ MEMO” button for an espresso or the “☕ MEMO” button for a long espresso. The brewing cycle starts.
- 4 After the prebrewing cycle, coffee begins to pour out of the dispensing spout.
- 5 Coffee brewing stops automatically when the set level is reached; however, you can stop it earlier by pressing the “☕ MEMO” button.

After brewing, the machine returns to the main menu.

Repeat the steps described above to brew more cups of coffee using pre-ground coffee.



Note:

If no pre-ground coffee is poured into the pre-ground coffee compartment, only water will be dispensed.

If the dose is excessive or 2 or more scoops of pre-ground coffee are added, the machine will not brew the product and any ground coffee will be discharged into the coffee grounds drawer.

DISPENSING STEAM / BREWING CAPPUCCINO

**Warning:**

Danger of burning! Dispensing may be preceded by small jets of hot water. The Classic Milk Frother may reach high temperatures. Never touch it with bare hands. Use the appropriate protective handle only.

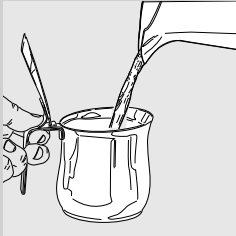

- 1 Fill 1/3 of a container with cold milk.

**Note:**

When preparing your cappuccino, use cold (~5°C / 41°F) milk with a protein content of at least 3% to ensure optimum results. Whole milk or skimmed milk may be used depending on individual taste.

**Note:**

When you plan to dispense steam right after turning on the machine or after brewing a coffee, any water still in the circuit may need to be dispensed first. To do this, press the “☺” button to dispense steam for a few seconds. Then press the “☺
MEMO” button to stop dispensing. Continue with step 2.



- 2 Immerse the Classic Milk Frother in milk.

- 3 Press the “☺” button to start dispensing steam.

**Note:**

Steam dispensing stops after 3 minutes. Press the “☺” button to start dispensing steam again.

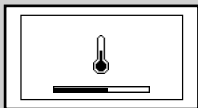

Green

- 4 This icon is displayed during the preheating time required by the machine.

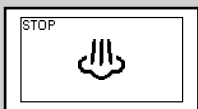

Green

- 5 Froth milk by gently swirling the container and moving it up and down.

- 6 When milk froth has the desired consistency, press the “☺
MEMO” button to stop dispensing steam.

**Note:**

After pressing the “☕
MEMO” button, it will take a few seconds before the machine stops dispensing steam completely.

**Caution:**

After frothing milk, a small quantity of hot water must be dispensed into a container. Remove the external part of the Classic Milk Frother and wash it with lukewarm water.

**Note:**

You can brew an espresso or dispense hot water straight after dispensing steam.

HOT WATER DISPENSING**Warning:**

Danger of burning! Dispensing may be preceded by small jets of hot water. The Classic Milk Frother may reach high temperatures: never touch it with bare hands. Use the appropriate protective handle only.

Before dispensing hot water, make sure that the machine is ready to use and the water tank is filled.

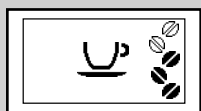

Green

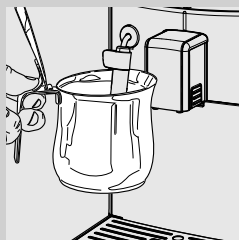

- 1 Place a container under the Classic Milk Frother.

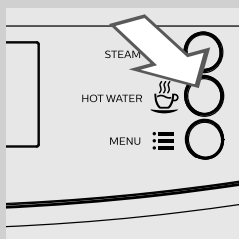

- 2 Press the “☕” button to start dispensing hot water.

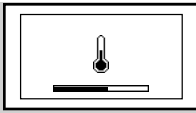

Green

- 3** This icon is displayed during the preheating time required by the machine.



Green

- 4** Pour the desired amount of hot water. To stop dispensing hot water, press the "MEMO" button.

CLEANING AND MAINTENANCE

Daily Cleaning of the Machine



Caution:

Timely cleaning and maintenance of your machine is very important as it prolongs the life of your machine. Your machine is continuously exposed to moisture, coffee and limescale! The activities you need to perform and their frequency are described in detail in this chapter. Not doing this will ultimately make your machine stop working properly. This repair is NOT covered by your warranty.



Note:

- Use a soft, dampened cloth to clean the machine.
- Only the cup holder grill can be washed in the dishwasher. Any other components must be washed with lukewarm water.
- Do not immerse the machine in water.
- Do not use alcohol, solvents, and/or abrasive objects to clean the machine.
- Do not dry the machine and/or its components using a microwave and/or standard oven.

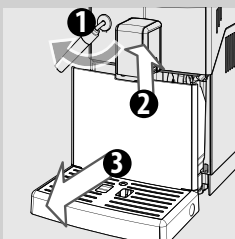

- 1** Empty and clean the coffee grounds drawer and the drip tray daily with the machine turned on.



Note:

If these operations are carried out when the machine is off, the machine will not reset the "empty coffee grounds drawer" alarm when restarted.

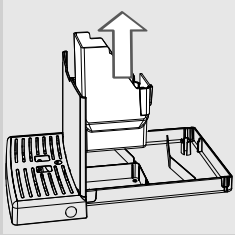

2 Remove the coffee grounds drawer and empty it.

3 Empty and clean the drip tray.

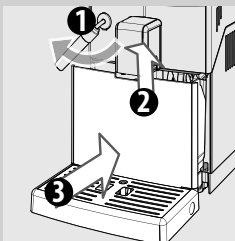

4 Insert the coffee grounds drawer back into the drip tray and place the drip tray back into the machine.

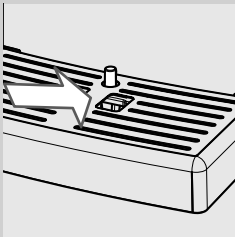

Note:

Empty and wash the drip tray also when the full drip tray indicator is raised.

Note:

Other maintenance operations can only be carried out when the machine is turned off and unplugged.

Cleaning of the Water Tank

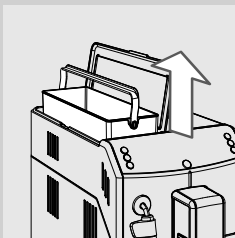

1 Remove the small white filter or the "INTENZA+" water filter (if installed) from the water tank and wash it with fresh water.

2 Put the small white filter or the "INTENZA+" water filter (if installed) back in its housing by gently pressing and turning it at the same time.

3 Fill the water tank with fresh water.

Daily Cleaning of the Classic Milk Frother

It is important that you clean the Classic Milk Frother daily or after each use as this preserves hygiene and ensures perfect milk froth consistency.

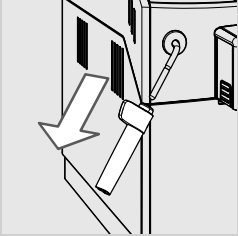

After frothing milk, a small quantity of hot water must be dispensed into a container.

Remove the external part of the Classic Milk Frother and wash it with lukewarm water.

Weekly Cleaning of the Machine

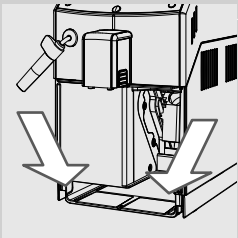

- 1 Clean the seat of the drip tray.

Weekly Cleaning of the Classic Milk Frother

The weekly cleaning is more thorough, since you need to disassemble all the Classic Milk Frother components.

The following cleaning operations are required:

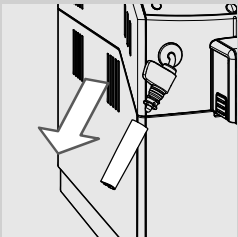

- 1 Remove the external part of the Classic Milk Frother. Wash it with lukewarm water.

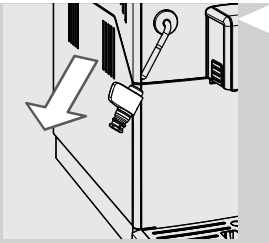



- 2** Remove the upper part of the Classic Milk Frother from the steam/hot water wand.
- 3** Wash the upper part of the Classic Milk Frother with fresh water.
- 4** Clean the steam/hot water wand of the Classic Milk Frother with a wet cloth to remove milk residues.
- 5** Put the upper part back into the steam/hot water wand (make sure it is completely inserted).
- 6** Reassemble the external part of the Classic Milk Frother.

Weekly Cleaning of the Brew Group

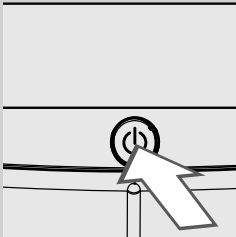
Clean the brew group at least once a week.



- 1** Turn off the machine by pressing the “” button. Wait until the “” button flashes and unplug the power cord.

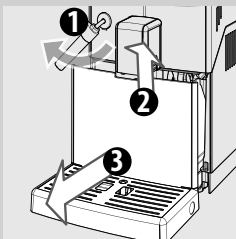

- 2** Remove the drip tray and coffee grounds drawer.

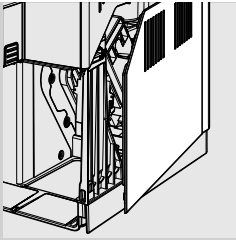

3 Open the service door.

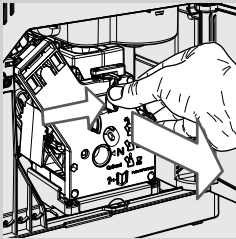

4 To remove the brew group, press the «PUSH» button and pull it by the handle. Pull it out horizontally without turning it.

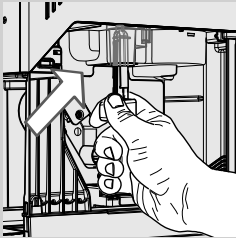

5 Thoroughly clean the coffee duct outlet with the special cleaning tool supplied with the machine or with a spoon handle. Make sure that the cleaning tool is inserted as shown in the figure.

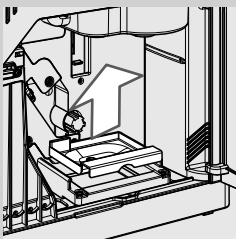
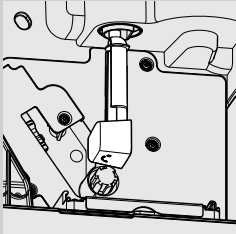

6 Remove the coffee residues drawer and wash it thoroughly.

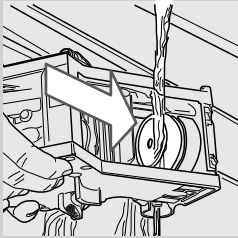

7 Thoroughly wash the brew group with fresh water and carefully clean the upper filter.

! **Caution:**

Do not use detergent or soap to clean the brew group.

8 Let the brew group air-dry thoroughly.

9 Thoroughly clean the inside of the machine using a soft, dampened cloth.

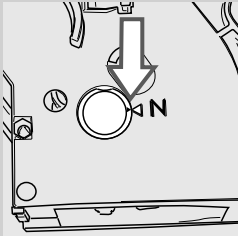

10 Make sure that the brew group is in the off position; the two reference marks must match. If they do not match, proceed as described in step 11.

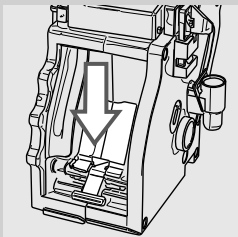

11 Gently pull down the lever until it is in contact with the brew group base and the two reference marks on the side of the brew group match.

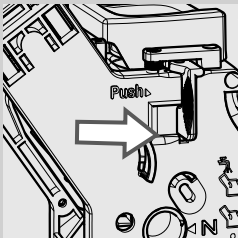

12 Press the "PUSH" button firmly.

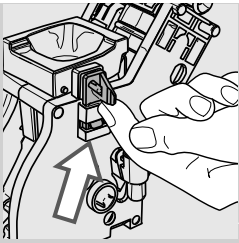

- 13** Make sure that the hook which locks the brew group is in the correct position. If it is still in the downward position, push it upward until it locks correctly into place.

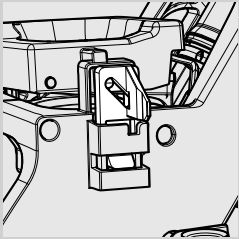

- 14** Insert the coffee residues drawer into its seat and ensure that it is correctly in place.

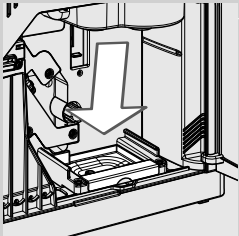

Note:

If the coffee residues drawer is not correctly positioned, the brew group may not fit into the machine.

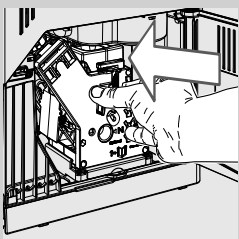

- 15** Insert the brew group back into its seat until it locks into place without pressing the "PUSH" button.

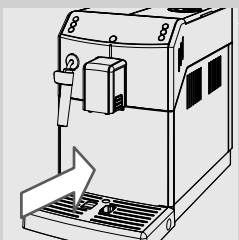

- 16** Insert the coffee grounds drawer with the drip tray back into the machine and close the service door.

Monthly Lubrication of the Brew Group



Lubricate the brew group after approximately 500 cups of coffee or once a month.

The grease to lubricate the brew group can be purchased separately. For further details, please refer to the maintenance products page in this user manual.



Caution:

Before lubricating the brew group, clean it with fresh water and let it dry as described in the “Weekly Cleaning of the Brew Group” chapter.

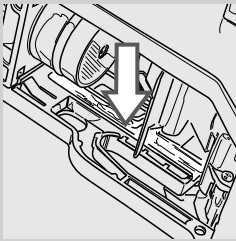

1 Apply the grease evenly on both side guides.

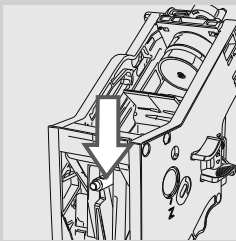
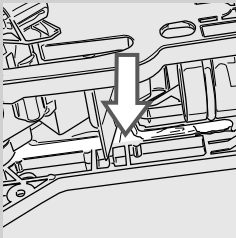

2 Also lubricate the shaft.

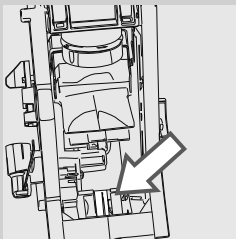

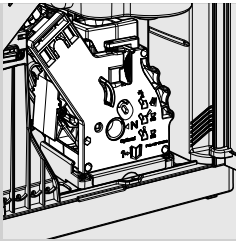

- 3 Insert the brew group into its seat until it locks into place (see the “Weekly Cleaning of the Brew Group” chapter).
- 4 Close the service door and insert the drip tray and coffee grounds drawer.

Monthly Cleaning of the Brew Group with “Coffee Oil Remover”



Besides weekly cleaning, we recommend performing a cleaning cycle with “Coffee Oil Remover” after approximately 500 cups of coffee or once a month. This operation completes the maintenance process for the brew group. You can purchase the “Coffee Oil Remover” separately. For further details, please refer to the maintenance products page in this user manual.



Caution:

The “Coffee Oil Remover” tablets are to be used for cleaning only and do not have a descaling function. For descaling, use the Saeco descaling solution and follow the procedure described in the “Descaling” chapter.

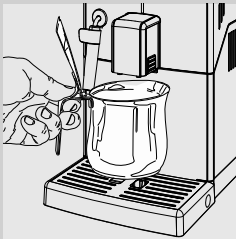

- 1 Place a container under the dispensing spout.

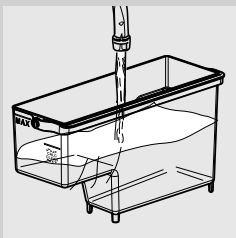

- 2 Make sure the water tank is filled with fresh water up to the “MAX” level.

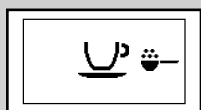
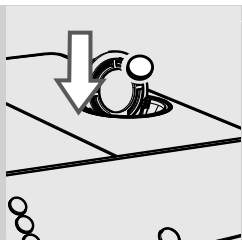

Green

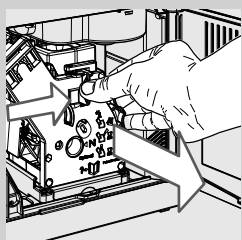
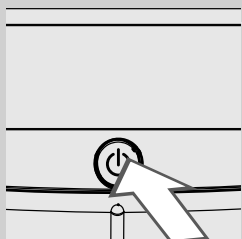
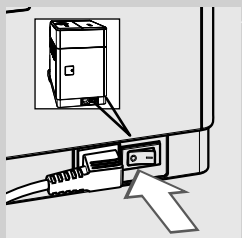

3 Put a “Coffee Oil Remover” tablet in the pre-ground coffee compartment.

4 Press the “” button to select the pre-ground coffee function without adding any pre-ground coffee into the compartment.

5 Press the “” button to start the coffee brewing cycle.

6 Wait until the machine has dispensed half a cup of water.

7 Switch the power button on the back of the machine to “0”.

8 Let the solution take effect for about 15 minutes. Make sure you discard the dispensed water.

9 Switch the power button on the back of the machine to “I”. To turn on the machine, press the “” button. Wait until the end of the automatic rinse cycle.

10 Remove the drip tray and the coffee grounds drawer and open the service door. Remove the brew group.

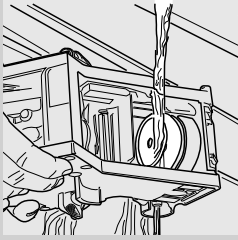

11 Wash the brew group thoroughly with fresh water.

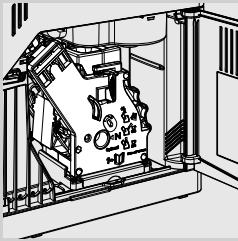

12 After rinsing the brew group, insert it back into its seat until it locks into place (see the “Weekly Cleaning of the Brew Group” chapter). Insert the drip tray and the coffee grounds drawer. Close the service door.



Green

13 Press the “☕” button to select the pre-ground coffee function without adding any pre-ground coffee into the compartment.

14 Press the “MEMO ☕” button to start the coffee brewing cycle.

15 Repeat steps 13 to 14 twice. Make sure you discard the dispensed water.

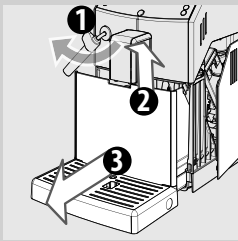

16 To clean the drip tray, place a “Coffee Oil Remover” tablet inside the tank and fill it 2/3rds full with hot water. Let the cleaning solution take effect for about 30 minutes, then rinse thoroughly.

Monthly Cleaning of the Coffee Bean Hopper

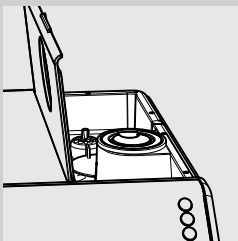

Clean the coffee bean hopper once a month when it is empty with a damp cloth to remove coffee oil. Then refill it with coffee beans.

DESCALING



Yellow

When the "CALC CLEAN" icon is displayed, you need to descale the machine.

The descaling cycle takes approx. 30 minutes.



Caution:

Not doing this will ultimately make your machine stop working properly. In this case, repair is NOT covered by warranty.



Warning:

Use the Saeco descaling solution only. Its formula has been designed to ensure better machine performance. The use of other products may damage the machine and leave residues in the water.

The Saeco descaling solution can be purchased separately. For further details, please refer to the maintenance products page in this user manual.



Warning:

Never drink the descaling solution or any products dispensed until the cycle has been carried out to the end. Never use vinegar as a descaling solution.



Note:

Do not remove the brew group during the descaling process.

Preparation Phase

To perform the descaling cycle, follow the steps below.

Before descaling:

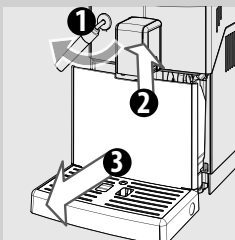

1

1 - Rotate the Classic Milk Frother;

2 - Raise the coffee dispensing spout;

3 - Remove and empty the drip tray and the coffee grounds drawer, then place them back.

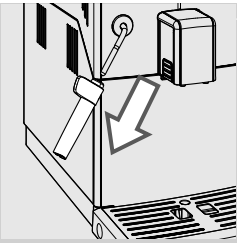

2 Remove the Classic Milk Frother from the steam/hot water wand.



Yellow

3 Press the “☰” button until this display is shown.

4 Press the “MEMO” button to start the descaling process.

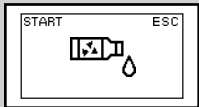

Yellow

Note:

If the “MEMO” button is pressed by mistake, press the “☰” button to quit.

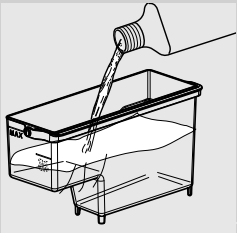

5 Remove the “INTENZA+” water filter (if installed) from the water tank and replace it with the small white original one.

6 Pour all the descaling solution into the water tank. Then fill the water tank with fresh water up to the **CALC CLEAN** level.



7 Put the water tank back into the machine.

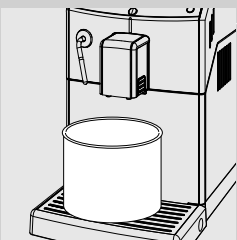

8 Place a large container (1.5 l) under both the steam/hot water wand and the dispensing spout.

Descaling Phase

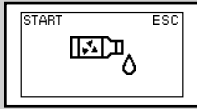

Yellow

- 9** Press the “MEMO” button to start the descaling cycle.



Yellow

- 10** The machine will start dispensing the descaling solution at regular intervals. The bar on the control panel shows the cycle progress. This procedure takes approx. 20 minutes.

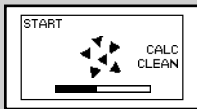

Yellow

Note:

The descaling cycle may be paused by pressing the “MEMO” button. To resume the cycle, press the “MEMO” button again. This allows you to empty the container or to leave the machine unattended for a short time.



Red

- 11** When this icon is displayed, the water tank is empty.

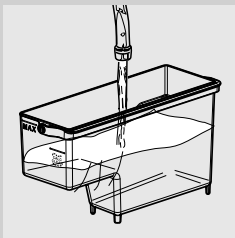

- 12** Remove the water tank, rinse it and fill it with fresh water up to the CALC CLEAN level. Put it back into the machine.

- 13** Empty the drip tray and place it back.

- 14** Empty the container and place it back under both the steam/hot water wand and the coffee dispensing spout.

Rinse Phase



Yellow

15 Press the “MEMO” button to start the rinse cycle.



Note:

The rinse cycle may be paused by pressing the “MEMO” button. To resume the cycle, press the “MEMO” button again. This allows you to empty the container or to leave the machine unattended for a short time.



Green

16 When the amount of water needed for the rinse cycle has been completely dispensed, this icon is displayed. Press the “MEMO” button to quit the descaling cycle.



Note:

If the water tank is not filled up to CALC CLEAN level, the machine might require the water tank to be filled up once more in order to complete the rinse cycle. Fill the water tank and put it back into the machine. Repeat from step 15.

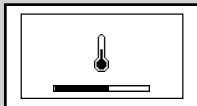

Yellow

17 The machine warms up and performs the automatic rinse cycle.

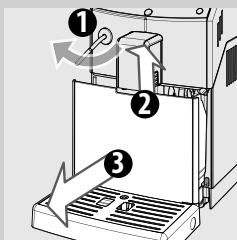

18 Remove and empty the container.

19 Empty the drip tray and place it back.

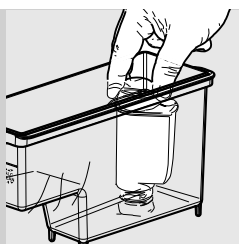

20 Remove the small white filter and replace the INTENZA+ water filter (if installed) in the water tank. Rinse it and fill it with fresh water up to the MAX level. Put it back into the machine.

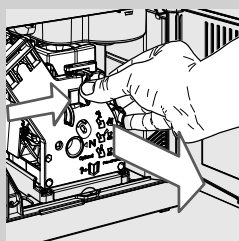

21 At the end of the descaling cycle, wash the brew group as described in the “Weekly Cleaning of the Brew Group” chapter.

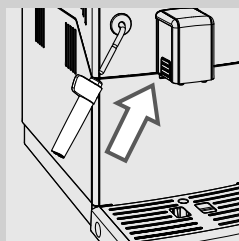

22 Reinsert the Classic Milk Frother.

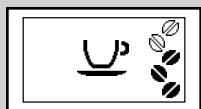

23 The machine is ready to brew coffee.

Interruption of the Descaling Cycle

Once the descaling cycle has started, it must be completed; do not turn off the machine mid-cycle.

If the machine stops, you can quit the cycle by pressing the on/off button.

If this occurs, or in the event of power failure or accidental disconnection of the power cord, empty and rinse carefully the water tank, then fill it up to the CALC CLEAN level.

Follow the instructions provided in the "Manual Rinse Cycle" chapter before brewing any beverage.

If the cycle was not completed, the machine will require another descaling cycle to be performed as soon as possible.

PROGRAMMING

You can customise the machine functions via the programming menu.

The Following Settings Can Be Adjusted

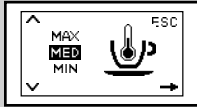

Yellow

Coffee Temperature

This function allows you to adjust the coffee brewing temperature.

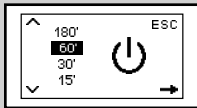

Yellow

Timer (stand-by)

This function allows you to adjust the time taken for the machine to go into stand-by mode after the last brewing.

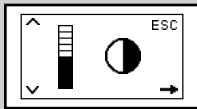

Yellow

Contrast

This function allows you to adjust the contrast of the display to better view the messages.

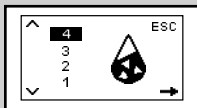

Yellow

Water Hardness

This function allows you to adjust the water hardness setting according to the area where you live.

- 1 = very soft water
- 2 = soft water
- 3 = hard water
- 4 = very hard water

For more details, please see the "Measuring and Programming Water Hardness" chapter.

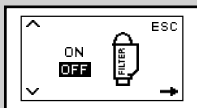

Yellow

"INTENZA+" Water Filter

This function allows you to manage the "INTENZA+" water filter. For more details, see the chapter related to filter handling.

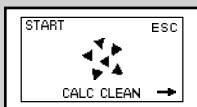

Yellow

Descaling Cycle

This function allows you to run the descaling cycle.



Yellow

Factory Settings

This function allows you to reset all factory values.

How to Program the Machine

This example shows how to program the timer. Proceed in the same way to program the other functions.



Green

The programming menu can only be accessed when the machine is on and shows this display.

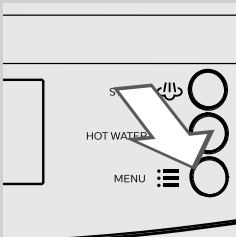

1 Press the “☰” button to access programming.

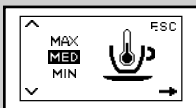

Yellow

2 The main screen will be displayed.

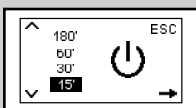

Yellow

3 Press the “☰” button to scroll the options until the timer function is shown.

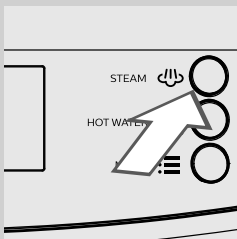
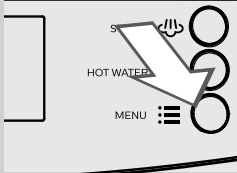
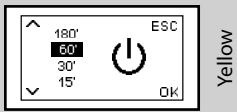
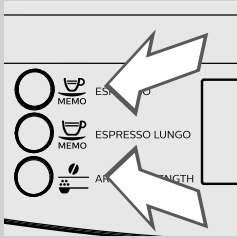

4 Press the “MEMO” and “MEMO” buttons to increase or decrease the value of the function.

5 Once the value has been changed, the “OK” message appears. Press the “MENU” button to confirm the change.

6 Press the “STEAM” button to exit programming.

Note:

The machine automatically exits programming mode if no button is pressed for 3 minutes. The values that have been changed but not confirmed will not be saved.

MEANING OF THE DISPLAY ICONS

This machine is equipped with a colour-coded system to make the user's understanding of the display signals easier. The icons are colour-coded according to the traffic light principle.

Ready Signals (Green Colour)



The machine is ready to brew products.

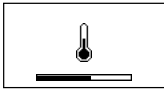

The machine is warming up to brew beverages or dispense hot water.

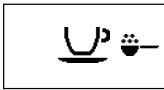

The machine is ready to brew pre-ground coffee.



Water dispensing.



Steam dispensing.



The machine is brewing one cup of espresso.



The machine is brewing one cup of long espresso.

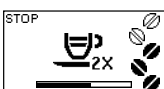

The machine is brewing two cups of espresso.

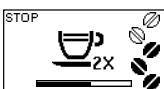

The machine is brewing two cups of long espresso.

Ready Signals (Green Colour)



The machine is programming the amount of espresso to be brewed.



The machine is programming the amount of long espresso to be brewed.



Espresso brewing using pre-ground coffee in progress.



Long espresso brewing using pre-ground coffee in progress.

Warning Signals (Yellow Colour)

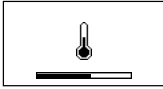

The machine is warming up.



The machine is performing the rinse cycle. Wait until the machine has completed the cycle.



The machine needs the "INTENZA+" water filter to be replaced.



The brew group is being reset due to machine reset.



Fill the coffee bean hopper with coffee beans and restart the cycle.



Prime the circuit.

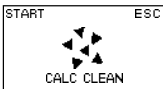

You need to descale the machine. Press the "MEMO" button to start the descaling process. Follow the steps described in the "Descaling" chapter of this manual. If you want to descale the machine later, press the "MEMO" button to continue using the machine.

Please note that not descaling your machine will ultimately make it stop working properly. In this case, repair is NOT covered under your warranty.

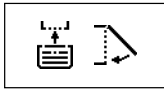
Warning Signals (Red Colour)

Completely insert the drip tray with the coffee grounds drawer into the machine and close the service door.



Fill the coffee bean hopper.



The brew group must be inserted into the machine.



Empty the coffee grounds drawer. Wait 5 seconds before reinserting it.



Fill the water tank.

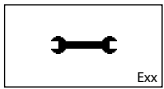

The machine is out of order. The error code is displayed in the right bottom corner. Turn off the machine. Turn it back on after 30 seconds. Try this 2 or 3 times. For error codes 1 -3 - 4 - 5, please also refer to the "Troubleshooting" chapter.

If the machine does not start, contact the Philips hotline in your country and quote the error code shown on the display. Contact details can be found in the warranty booklet packed separately or at www.philips.com/support.

TROUBLESHOOTING

This chapter summarizes the most common problems you could encounter with your machine.

If you are unable to solve the problem with the information below, visit **www.philips.com/support** for a list of frequently asked questions or contact the Philips hotline in your country.

Contact details can be found in the warranty booklet supplied separately or at **www.philips.com/support**.

Machine actions	Causes	Solutions
Error Code 1 Coffee grinder blocked.	Coffee outlet duct clogged.	Thoroughly clean the coffee outlet duct as described in the "Weekly Cleaning of the Brew Group" chapter.
Error Code 3-4 The brew group is blocked and cannot be pulled out.	The brew group is out of place.	Close the service door. Turn off and back on the machine. The brew group automatically returns to the initial position.
Error Code 5 Water circuit error.	Air in the water circuit.	Remove and put back the water tank a few times, making sure it is properly reinserted. Check that the water tank compartment is clean. If the Intenza+ filter is installed, remove it. Turn off and back on the machine. When the machine is ready for use, put the filter back.

Machine actions	Causes	Solutions
The machine does not turn on.	The machine is not connected to the electric network, or the power button is in the "O" position.	Connect the machine to the electric network and turn the power button to the "I" position.
The machine is in demo mode.	The "⏻" button was pressed and held for more than 8 seconds.	Turn the machine off and back on using the power button.
The drip tray gets filled although no water is drained.	Water is sometimes drained automatically by the machine into the drip tray to manage the rinsing of the circuits and ensure optimum machine performance.	This is a normal behaviour of the machine.
The red  icon is always displayed on the machine.	The coffee grounds drawer has been emptied with the machine off.	The coffee grounds drawer must always be emptied with the machine on. Wait until the  icon is displayed before refitting the drawer.
	The coffee grounds drawer has been emptied with the machine on without waiting at least 5 seconds before inserting it back.	Wait until the  icon is displayed before refitting the drawer.
The brew group cannot be removed.	The brew group is out of place.	Turn on the machine. Close the service door. The brew group automatically returns to the initial position.
	The coffee grounds drawer is inserted.	Remove the coffee grounds drawer before removing the brew group.
The brew group cannot be inserted.	The brew group is not in the off position.	Make sure that the brew group in the off position, as described in the "Weekly Cleaning of the Brew Group" chapter.
	The gearmotor is not in the correct position.	Insert the drip tray and the coffee grounds drawer. Close the service door. Turn on the machine without inserting the brew group. The gearmotor moves back to the correct position. Turn off the machine and reinsert the brew group as described in the "Weekly Cleaning of the Brew Group" chapter.
Coffee is not hot enough.	The cups are cold.	Preheat the cups with hot water.
	The temperature is not correctly set.	Set the temperature as described in the "Programming" chapter.
The coffee is too weak (see note).	This might occur when the machine is automatically adjusting the dose.	Brew a few cups of coffee as described in the "Saeco Adapting System" chapter.
	Coffee is too coarse.	Change coffee blend or adjust grinding as explained in the "Adjusting the Ceramic Coffee Grinder" chapter.
Coffee does not have enough crema (see note).	The blend is unsuitable, coffee is not freshly roasted or the grind is too coarse.	Change coffee blend or adjust the grind setting as explained in the "Adjusting the Ceramic Coffee Grinder" chapter.

Machine actions	Causes	Solutions
Coffee is not brewed, is brewed slowly or only a few drops are brewed (see note).	The coffee grind is too fine.	Change coffee blend or adjust grinding as explained in the "Adjusting the Ceramic Coffee Grinder" chapter.
	The circuit is not primed.	Prime the circuit (see the "Using the Machine for the First Time" chapter).
	The brew group is dirty.	Clean the brew group (see the "Weekly Cleaning of the Brew Group" chapter).
	The dispensing spout is dirty.	Clean the dispensing spout and its holes.
	The machine circuit is clogged by limescale.	Descale the machine.
Coffee leaks out of the dispensing spout.	The dispensing spout is clogged.	Clean the dispensing spout and its holes.
No hot water or steam is dispensed.	The hole of the steam/hot water wand is clogged.	Clean the hole of the steam wand using a pin. Make sure that the machine is off and has cooled down before performing this operation.
	The circuit is not primed.	Prime the circuit (see the "Using the Machine for the First Time" chapter).
	The machine circuit is clogged by limescale.	Descale the machine.
	The Classic Milk Frother is dirty.	Clean the Classic Milk Frother.
The descaling cycle cannot be completed.	The water dispensed for the rinse cycle is not enough.	Press the on/off button and follow the instructions described in the "Interruption of the Descaling Cycle" section.

**Note:**

These problems can be considered normal if the coffee blend has been changed or if the machine has just been installed. In this case, wait until the machine performs a self-adjusting operation as described in the "Saeco Adapting System" chapter.

ENERGY SAVING

Stand-by



The Philips super automatic espresso coffee machine is designed for energy saving, as proven by the Class A energy label.

After 15 minutes of inactivity, the machine turns off automatically (unless a different stand-by time has been programmed). If a product has been brewed, the machine performs a rinse cycle.

In stand-by mode, the energy consumption is below 1Wh.

To turn on the machine, press the “” button (if the power button on the back of the machine is set to “I”). If the boiler is cold, the machine performs a rinse cycle.

TECHNICAL SPECIFICATIONS

The manufacturer reserves the right to make changes to the technical specifications of the product.

Nominal Voltage - Power Rating - Power Supply	See data plate on the inside of the service door
Housing material	Thermoplastic material
Size (w x h x d)	215 x 330 x 429 mm
Weight	6.7 kg
Power cord length	800 - 1200 mm
Control panel	Front panel
Classic Milk Frother	Special for cappuccino
Cup size	Up to 152 mm
Water tank	1.8 litres - Removable type
Coffee bean hopper capacity	250 g
Coffee grounds drawer capacity	15
Pump pressure	15 bar
Boiler	Stainless steel type
Safety devices	Thermal fuse

FACTORY SETTINGS

Beverage Adjustment

Beverages	Predefined quantity	Aroma Strength	Adjustable:
Espresso	40 ml	3	20 ml - 140 ml
Long espresso	120 ml	3	20 ml - 140 ml

Note: the values provided may vary.

WARRANTY AND SERVICE

Warranty

For detailed information on your warranty and related conditions, please read the warranty booklet supplied separately.

Service

We want to ensure that you remain satisfied with your machine. If you have not already done so, please register your purchase at **www.philips.com/welcome**. This will enable us to stay in contact with you and send you cleaning and descaling reminders.

If you need service or support, please visit the Philips website at **www.philips.com/support** or contact the Philips hotline in your country. The contact details can be found in the warranty booklet supplied separately or at **www.philips.com/support**.

ORDERING MAINTENANCE PRODUCTS

For cleaning and descaling, use Philips maintenance products only. You can purchase the products at the Philips online shop at www.shop.philips.com/service, from your local dealer or at authorised service centres.

If you have any difficulties obtaining maintenance products for your machine, please contact the Philips hotline in your country.

Contact details can be found in the warranty booklet packed separately or at www.philips.com/support.

Overview of maintenance products



- Descaling solution CA6700



- INTENZA+ Water filter cartridge CA6702



- Grease HD5061



- Coffee Oil Remover CA6704



- Maintenance Kit CA6706

02



The manufacturer reserves the right to make changes without prior notice.

www.philips.com/welcome



421946027951

Rev.00 del 30-04-15

02

EN