



**PHILIPS**

Super automatic  
espresso machine

3100 series

EP3519, EP3510

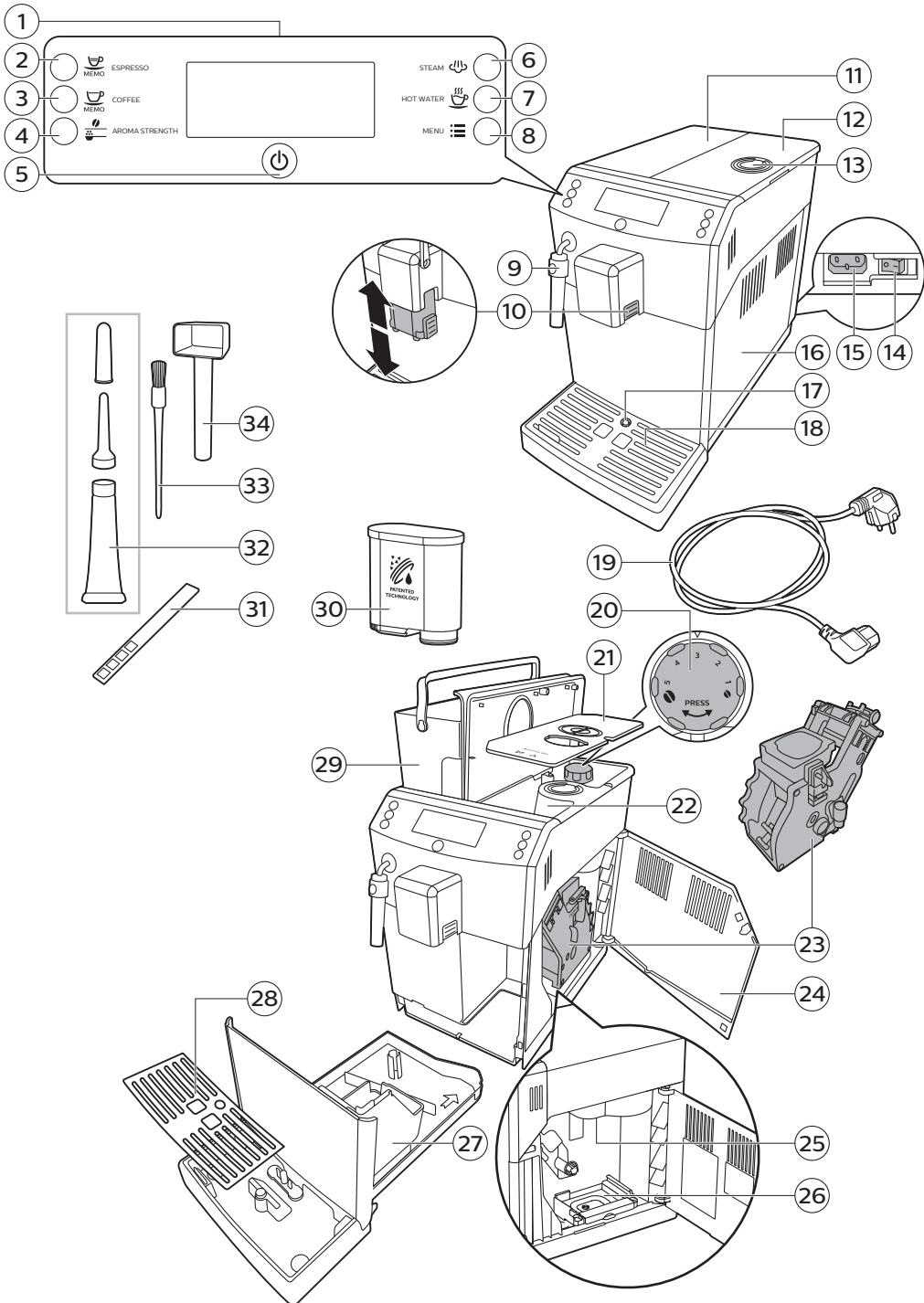

# Contents

Machine overview .....	5
Introduction .....	5
First installation .....	6
AquaClean filter .....	6
Activating the AquaClean filter .....	6
Replacing the AquaClean filter .....	7
Replacing the AquaClean filter after 8 filters were used .....	8
Measuring the water hardness .....	8
Control panel and display .....	9
One-touch beverage buttons .....	9
Navigation buttons .....	9
MENU button .....	9
AROMA STRENGTH button .....	9
Brewing coffee .....	10
Brewing coffee with beans .....	10
Brewing coffee with pre-ground coffee .....	10
Frothing milk .....	10
Hot water .....	11
Adjusting volume and taste .....	11
Adjusting coffee volume .....	11
Adjusting coffee strength .....	12
Adjusting grinder settings .....	12
Cleaning and maintenance .....	13
Cleaning table .....	13
Cleaning the brew group .....	14
Cleaning the brew group under the tap .....	14
Cleaning the brew group with coffee oil remover tablets .....	14
Reinserting the brew group .....	15
Lubrication .....	16
Cleaning the classic milk frother .....	17
After the last usage of the day .....	17
Descaling procedure .....	17
What to do if the descaling procedure is interrupted .....	18
Warning icons and error codes .....	19
Meaning of the warning icons .....	19
Meaning of the error codes .....	19
Troubleshooting .....	20

## Machine overview

1	User interface	18	Drip tray
2	ESPRESSO button	19	Cord
3	COFFEE button	20	Grind setting knob
4	AROMA STRENGTH button	21	Cover of bean hopper
5	Standby button	22	Bean hopper
6	STEAM button	23	Brew group
7	HOT WATER button	24	Inside of service door with contact information
8	MENU button	25	Coffee exit duct
9	Classic milk frother	26	Coffee residues drawer
10	Adjustable coffee dispensing spout	27	Coffee grounds container
11	Lid of water tank	28	Drip tray cover
12	Lid of bean hopper	29	Water tank
13	Lid of pre-ground coffee compartment	30	AquaClean filter
14	Main switch	31	Water hardness test strip
15	Socket for cord	32	Grease tube with application tip and cap
16	Service door	33	Cleaning brush
17	'Drip tray full' indicator	34	Measuring scoop

## Introduction

Congratulations on your purchase of a Philips full-automatic coffee machine! To fully benefit from the support that Philips offers, please register your product at [www.philips.com/coffee-care](http://www.philips.com/coffee-care).

Read the separate safety booklet carefully before you use the machine for the first time and save it for future reference.

To help you get the best out of your coffee machine, Philips offers full support in 4 different ways:

- The separate quick start guide for first installation and first use.
- This user manual for more detailed information on how to use the machine, how to keep it clean, how to descale it and how to solve problems.



- This is the QR code. Scan this code to access instruction videos on how to brew the best coffees, how to clean the machine and for a list of frequently asked questions. ([www.philips.com/coffee-care](http://www.philips.com/coffee-care))
- The separate booklet with important safety information.

## First installation

For first installation, follow the instructions on the separate quick start guide.

Note: This machine has been tested with coffee. Although it has been carefully cleaned, there may be some coffee residues left. We guarantee, however, that the machine is absolutely new.

Note: You can install the AquaClean filter during the first installation procedure (see separate quick start guide). If you skip installation of the AquaClean filter at first use, you can install it later by entering the menu (see 'Activating the AquaClean filter').

## AquaClean filter

The AquaClean filter is designed to reduce limescale deposits in your coffee machine and provide filtered water to preserve the aroma and flavor of each cup of coffee. If you use a series of 8 AquaClean filters as indicated in this user manual, you don't have to descale your machine for up to 5000 cups.

Note: Your machine has to be completely limescale-free before you start to use the AquaClean filter. If you did not activate the filter during first installation, you need to descale the machine before you activate the filter.

## Activating the AquaClean filter

Note: Always confirm activation of the AquaClean filter in the machine menu as described below. You also need to do this after replacing the AquaClean filter. By activating the AquaClean filter in the machine menu, the machine monitors the number of filters used. When the filter has been replaced 8 times, the machine reminds you to descale it.

- 1 For instructions on how to place the AquaClean filter in the water tank, see the separate quick start guide.

Note: Shake the AquaClean filter for about 5 seconds, immerse it upside down in a jug with cold water and wait until no more air bubbles come out.



- 2 Press the MENU button, select MENU and press the OK button to confirm. Scroll to AQUACLEAN FILTER. Press the OK button to confirm.
  - The display shows the number of AquaClean filters that have been installed previously from 0 to 8 filters.

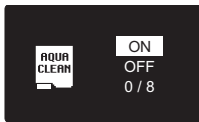

- 3 Select ON on the display, press the OK button to confirm.



- 4 The display automatically updates the number of filters used.



- Then the 'machine ready' screen appears with the AquaClean 100% icon to indicate that the filter has been installed.
- 5 Dispense 2 cups of hot water (0.5 l) to complete the activation. Discard this water.

## Replacing the AquaClean filter

Note: Replace the AquaClean filter as soon as the capacity has dropped to 0% and the filter icon flashes quickly. Replace the AquaClean filter at least every 3 months, even if the machine has not yet indicated that replacement is required.

Tip: We advise you to buy a new filter when the capacity has dropped to 10% and the filter icon starts flashing slowly. This ensures that you can replace the filter when the capacity has dropped to 0%.



- 1 Take out the AquaClean filter and replace it by a new AquaClean filter (also see the separate quick start guide).
- 2 Press the MENU button, scroll to AQUACLEAN FILTER and press the OK button to confirm.



- The display asks if you want to activate a new filter.
- 3 Press the OK button to confirm.

## 8 English



- The display automatically updates the number of filters used.
- 4 Dispense 2 cups of hot water (0.5 l) to complete the activation. Discard this water.

## Replacing the AquaClean filter after 8 filters were used

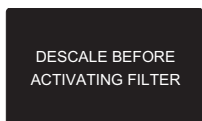

- 1 When the filter icon starts flashing on the display, press the MENU button, scroll to AQUACLEAN FILTER and press the OK button to confirm.
  - The display tells you that you need to descale the machine before activating the new filter.
- 2 Press the OK button to start the descaling procedure.
  - Press the escape button several times to leave the filter menu if you do not want to descale right away.
- 3 At the end of the descaling procedure, the display asks you if you want to install the AquaClean filter.
  - Follow the steps in 'Replacing the AquaClean filter'.

## Measuring the water hardness

Note: If you have installed the AquaClean filter, you do not need to set the water hardness.

To be able to adjust the machine settings to the water in your region, please measure the water hardness with the water hardness test strip supplied. The default water hardness of the machine is set to the highest level (4). If the measured water hardness is different, adjust the setting in the machine menu.

- 1 Immerse the water hardness test strip (supplied with the machine) in tap water for 1 second.
- 2 Remove the water hardness test strip and wait for 1 minute.
- 3 Check how many squares have turned red and check the water hardness in the table below.

number of red squares	value to be set	water hardness
■□□□	1	very soft water
■ ■ □ □	2	soft water
■ ■ ■ □	3	hard water
■ ■ ■ ■	4	very hard water

- 4 Press the MENU button, select menu and scroll to select water hardness. Select the preferred water hardness setting and press the OK button to confirm.

## Control panel and display





This espresso machine has a self-explaining display for easy use. Read the sections below for a quick explanation of the buttons.

### One-touch beverage buttons

Use the one-touch beverage buttons to quickly prepare one of the preset beverages: ESPRESSO, COFFEE, STEAM and HOT WATER.

### Navigation buttons

Some of the one-touch beverage buttons have a double function; use these buttons to navigate through the menu.

	➔ ESPRESSO button = Escape button: press this button to return to the main menu.		STEAM button = Up button: press this button to scroll up through the display.
	✔ AROMA STRENGTH button = OK button: press this button to select, confirm or stop a function.		MENU button = Down button: press this button to scroll down through the display menu.

### MENU button

Use the MENU button to change the following settings:

- Coffee temperature
- Stand-by time: this is the time after which the machine goes into standby mode.
- Display contrast
- Water hardness: to be able to adjust the machine settings to the water in your region, please measure the water hardness.
- To activate the AquaClean filter
- To start descaling
- To restore to the factory settings

### AROMA STRENGTH button

Use the AROMA STRENGTH button to adjust the coffee strength or to brew pre-ground coffee.



## Brewing coffee

### Brewing coffee with beans

**Caution: Only use espresso beans. Never put ground coffee, unroasted coffee beans or caramelized coffee beans in the bean hopper, as this may cause damage to the machine.**

To brew coffee, follow the instructions on the separate quick start guide.

To brew two cups of espresso, press the ESPRESSO button twice. The machine automatically carries out two grinding cycles in sequence.

Note: Using the cover of the bean hopper helps to keep the beans fresh.

### Brewing coffee with pre-ground coffee

When you brew coffee with pre-ground coffee, use the measuring scoop supplied to put the correct dose in the pre-ground coffee compartment.

- 1 Open the lid of the pre-ground coffee compartment.
- 2 Pour **one** measuring scoop of pre-ground coffee into the pre-ground coffee compartment and close the lid.

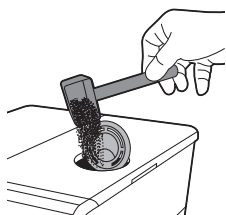

**Caution: Do not put any other substance than pre-ground coffee in the pre-ground coffee compartment, as this may damage the machine.**

- 3 Place a cup under the coffee dispensing spout.
- 4 Press the AROMA STRENGTH button and select the pre-ground coffee brewing function.
- 5 Press the ESPRESSO button.  
The machine automatically starts brewing the selected beverage.

Note: With pre-ground coffee you can only brew one coffee at a time.

## Frothing milk

**Warning: Danger of scalding! Dispensing may be preceded by small jets of hot water. Use the appropriate protective handle only.**

Note: Use cold milk (at a temperature of approximately 5°C/41°F) with a protein content of at least 3% to ensure an optimal frothing result. You can use whole milk or semi-skimmed milk. It is also possible to use skimmed milk, soy milk and lactose-free milk.

Note: We advise you to rinse the water circuit before use. Press the STEAM/WATER button to dispense steam for a few seconds.

- 1 Fill 1/3 of a jug with cold milk.
- 2 Insert the classic milk frother into the milk.
- 3 Press the STEAM button.
  - The machine starts dispensing steam.

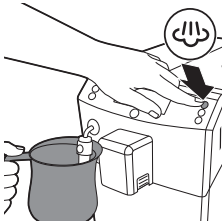

- 4 Froth the milk by gently swirling the jug and moving it up and down.
- 5 Press the OK button to stop frothing.

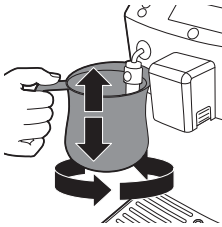

## Hot water

**Warning: Danger of scalding! Dispensing may be preceded by small jets of hot water. Use the appropriate protective handle only.**

- 1 Place a jug under the classic milk frother.
- 2 Press the HOT WATER button.
  - The machine starts dispensing water.
- 3 To stop dispensing hot water, press the OK button.

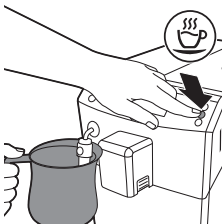

## Adjusting volume and taste

### Adjusting coffee volume

You can adjust the volume of the beverage brewed according to your taste and to the size of the cups.

- 1 To adjust the espresso volume, press and hold the ESPRESSO button until the display shows the MEMO icon.

- The machine enters the programming phase and starts to brew the selected beverage.
- 2 Press the OK button when the cup contains the desired amount of espresso.
    - The tick on the display shows that the button is programmed: every time it is pressed, the machine brews the set espresso volume.

Note: To set the volume of coffee, follow the same procedure: press and hold the button of the beverage until the MEMO icons appears on the display and press the OK button when the cup contains the desired amount.

## Adjusting coffee strength

To change the coffee strength, press the AROMA STRENGTH button. Each time you press the AROMA STRENGTH button, the aroma strength changes by one degree. The display shows the chosen strength, which is only saved if you brew a coffee.

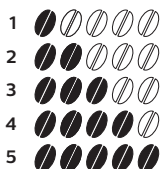

- 1 Very mild
- 2 Mild
- 3 Regular
- 4 Strong
- 5 Very strong

Note: After adjusting the coffee strength, the display shows the main menu again and saves the chosen aroma strength when you brew a coffee.

## Adjusting grinder settings

You can adjust the grinder settings by using the grind setting knob inside the bean container.

Note: You can only adjust the grind settings when the machine is grinding coffee beans.

Caution: Do not turn the grind setting knob more than one notch at a time to prevent damage to the grinder.

- 1 Place a cup under the coffee dispensing spout.
- 2 Open the lid of the bean hopper.
- 3 Press the ESPRESSO button.
- 4 When the grinder starts grinding, press down the grind setting knob and turn it to the left or right.
  - There are 5 different grind settings you can choose from. The lower the setting, the stronger the coffee.

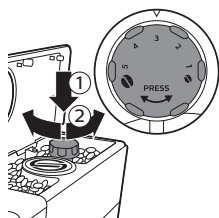

## Cleaning and maintenance

Note: Consult the table below for when and how to clean all detachable parts of the machine. For more detailed information on how to clean the brew group and how to descale the machine, read the corresponding chapters below and visit the dedicated website [www.philips.com/coffee-care](http://www.philips.com/coffee-care).

### Cleaning table

Part description	When to clean	How to clean
Brew group	Weekly	Remove the brew group and clean it under the tap (see 'Cleaning the brew group under the tap').
	Depending on the type of usage	Lubricate the brew group (see 'Lubrication').
	Monthly	Clean the brew group with Philips/Saeco coffee oil remover tablets. (see 'Cleaning the brew group with coffee oil remover tablets')
Classic milk frother	After the last usage of the day	Rinse with fresh water and clean the steam wand with a wet cloth (see 'After the last usage of the day ').
Drip tray	As soon as the red 'drip tray full' indicator pops up through the drip tray.	Empty the drip tray and clean it under the tap.
Coffee grounds container	When it suits you	Empty the coffee grounds container and clean it under the tap. Make sure the machine is switched on while you empty and clean the coffee grounds container.
Water tank	When it suits you	Clean it under the tap.
Pre-ground coffee compartment/coffee exit duct	Weekly	Clean the top part with a spoon handle as shown below.

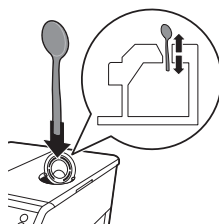

## Cleaning the brew group



Note: Scan the QR code or visit [www.philips.com/coffee-care](http://www.philips.com/coffee-care) for support videos on how to remove and clean the brew group.

**Caution: Do not clean the brew group in the dishwasher and do not use washing-up liquid or a cleaning agent to clean it. This may cause the brew group to malfunction and may have a negative effect on the coffee taste.**

### Cleaning the brew group under the tap

- 1 Switch off the machine and unplug it.
- 2 Remove the drip tray with the coffee grounds container.
- 3 Open the service door.
- 4 Press the PUSH button (1) and pull at the grip of the brew group to remove it from the machine (2).

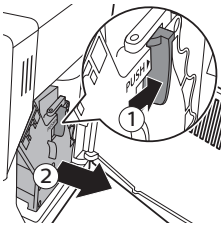

- 5 Rinse the brew group thoroughly with lukewarm water. Clean the upper filter carefully.
- 6 Let the brew group air-dry.

Note: Do not dry the brew group with a cloth to prevent fibers from collecting inside the brew group.

### Cleaning the brew group with coffee oil remover tablets

**Caution: Only use Philips/Saeco coffee oil remover tablets for cleaning. They do not have a descaling function.**

- 1 Place a container under the coffee dispensing spout.
- 2 Press the AROMA STRENGTH button and select pre-ground coffee.

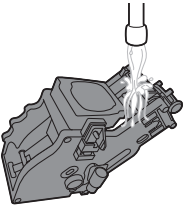

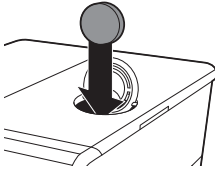

- 3 Put a coffee oil remover tablet in the pre-ground coffee compartment.
- 4 Press the CLASSIC COFFEE button. The machine dispenses water from the coffee dispensing spout.
- 5 When the progress bar has reached the middle, set the main switch on the back of the machine to OFF.
- 6 Let the coffee oil remover solution act for approximately 15 minutes.
- 7 Set the main switch to ON. Press the standby button.
- 8 Wait until the machine performs an automatic rinsing cycle.
- 9 Perform the 'Weekly cleaning of the brew group' procedure.
- 10 Remove the drip tray with the coffee grounds container and empty them. Then place them back into the machine.
- 11 Press the AROMA STRENGTH button and select pre-ground coffee.
- 12 Press the CLASSIC COFFEE button. The machine dispenses water from the coffee dispensing spout.
- 13 Repeat steps 11 and 12 twice. Discard the dispensed water.

### Reinserting the brew group

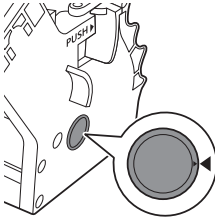

- 1 Before you slide the brew group back into the machine, make sure the two yellow reference signs on the side match. If they do not match, perform the following step:

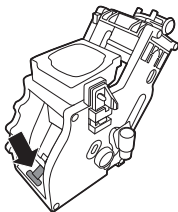

- Make sure the lever is in contact with the base of the brew group.
- 2 Make sure that the yellow locking hook of the brew group is in the correct position.

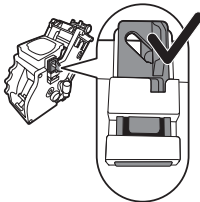

- To position the hook correctly, push it upwards until it is in uppermost position.

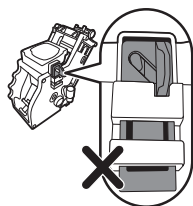

- The hook is not positioned correctly if it is still in bottommost position.
- 3 Slide the brew group back into the machine along the guiding rails on the sides until it locks into position with a click.

**Caution: Do not press the PUSH button.**

- 4 Close the service door.

## Lubrication

For optimal performance of the machine, you have to lubricate the brew group. See table below for the lubrication frequency. For support videos visit our website: [www.philips.com/coffee-care](http://www.philips.com/coffee-care).

Usage frequency	Nr of beverages brewed daily	Lubrication frequency
Low	1-5	Every 4 months
Normal	6-10	Every 2 months
Heavy	>10	Every month

- 1 Switch off the appliance and unplug it.
- 2 Remove the brew group and rinse it under a lukewarm tap (see 'Cleaning the brew group under the tap'). Then let it air-dry.
- 3 Apply a thin layer of grease around the shaft in the bottom of the brew group.

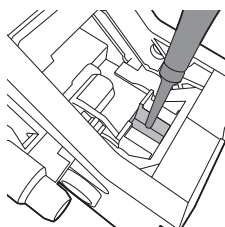

- 4 Apply a thin layer of grease to the rails on both sides (see figure).
- 5 Reinsert the brew group (see 'Reinserting the brew group').

You can use the grease tube multiple times.

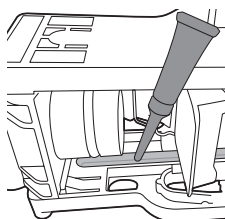

## Cleaning the classic milk frother

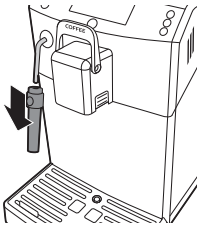

### After the last usage of the day

- 1 Remove the classic milk frother from the steam wand and rinse it with fresh water.
- 2 Clean the steam wand with a wet cloth.
- 3 Reassemble all the classic milk frother parts.

## Descaling procedure

When the display shows START CALC CLEAN, you need to descale the machine. If you do not descale the machine when this message appears on the display, the machine will eventually stop working properly. In that case, repairs are not covered by the warranty.

Only use Philips/Saeco descaling solution to descale the machine. The use of other products may damage the machine and leave residues in the water. You can buy descaling solution in the online shop at [www.philips.com/coffee-care](http://www.philips.com/coffee-care).

The descaling procedure lasts 30 minutes and consists of a descaling cycle and a rinsing cycle. You can pause the descaling or rinsing cycle by pressing the escape button. To continue the descaling or rinsing cycle, press the OK button.

**Note:** Do not remove the brew group during the descaling procedure.

**Warning: Do not drink the descaling solution or the water dispensed during the descaling procedure.**

- 1 Remove the drip tray and the coffee grounds container, empty and clean them and put them back into place.
- 2 Remove the classic milk frother from the steam wand.
- 3 Place a large container (1.5 l) under the coffee dispensing spout.
- 4 When the display shows START CALC CLEAN, press the OK button to start the descaling procedure.

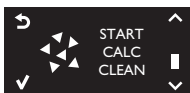

- The display reminds you that you have to remove the AquaClean filter.

**Note:** You can press the escape button if you want to start the descaling procedure later. To perform the descaling procedure later, press the MENU button, select MENU and scroll to select DESCALING. Press OK to confirm.



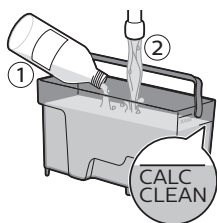

- 5 Pour the descaling solution into the water tank. Fill the water tank with fresh water up to the CALC CLEAN level indication. Place the water tank back into the machine. Press the OK button to confirm.
  - The first phase of the descaling procedure starts. The machine starts dispensing solution at intervals.
  - The display shows the descaling icon, the phase indication and the duration. This first phase takes 20 minutes.
- 6 Let the machine dispense the descaling solution until the water tank is empty.
- 7 Remove the water tank and rinse it.
- 8 Fill the water tank with fresh water up to the CALC CLEAN level indication. Place the water tank back into the machine.
- 9 Remove and empty the container and place it back under the coffee dispensing spout. Press OK to confirm.
- 10 The second phase of the descaling procedure starts, which is the rinsing cycle. This phase takes 3 minutes. The display shows the rinsing icon and the duration of the phase.

Note: If the water tank is not filled up to the CALC CLEAN level, the machine may require another rinsing cycle.

- 11 Wait until the machine stops dispensing water. The descaling procedure is finished when the tick appears on the display.
- 12 Press the OK button to exit the descaling cycle. The machine starts heating up and performs the automatic rinsing cycle.
- 13 Remove and empty the container.
- 14 Clean the brew group by performing the 'Weekly brew group cleaning' cycle.
- 15 Install a new AquaClean filter in the water tank.

Tip: Using the AquaClean filter reduces the need for descaling!

- 16 Reinsert the classic milk frother.

### What to do if the descaling procedure is interrupted

If the machine gets stuck during descaling, you can exit the descaling procedure by pressing the standby button. If this occurs, or in case of a power failure or accidental disconnection of the cord, do the following:

- 1 Empty and rinse the water tank thoroughly.
- 2 Fill the water tank with fresh water up to the CALC CLEAN level indication and switch the machine back on. The machine will heat up and perform an automatic rinsing cycle.
- 3 Before brewing any beverages, perform a manual rinsing cycle. To perform a manual rinsing cycle, first dispense half a water tank of hot water and then brew 2 cups of pre-ground coffee without adding ground coffee (see 'Brewing coffee with pre-ground coffee').

Note: If the descaling procedure was not completed, the machine will require another descaling procedure as soon as possible.

## Warning icons and error codes

### Meaning of the warning icons



Fill the water tank with fresh water to the MAX level indication.



The brew group is blocked by coffee powder. Clean the brew group.



The bean hopper is empty. Put new coffee beans in the bean hopper.



Insert the drip tray and close the service door.



The brew group is not in the machine or it is not inserted correctly. Insert the brew group.



The CoffeeSwitch is in the wrong position for the selected beverage. Push the lever down to the ESPRESSO position.



The coffee grounds container is full. Make sure the machine is switched on. Then remove and empty the coffee grounds container.



The CoffeeSwitch is in the wrong position for the selected beverage. Push the lever up to the COFFEE position.



If the display shows an error code, check section 'Meaning of the error codes' to see what the code on the display means and what you can do. The machine cannot be used when this icon is on the display.

### Meaning of the error codes

Below you find a list of the error codes showing problems that you can solve yourself. Support videos are available on [www.philips.com/coffee-support](http://www.philips.com/coffee-support). If another error code appears, please contact the Philips Consumer Care Center in your country. For contact details, see the warranty leaflet.

Error code	Problem	Cause	Possible solution
01	The coffee grinder is blocked	The coffee exit duct is clogged.	Switch off the machine. Clean the coffee exit duct thoroughly with the handle of the measuring spoon or a spoon handle. Then switch the machine on again.
03 - 04	There is a problem with the brew group.	The brew group is dirty or not well greased.	Switch off the machine. Rinse the brew group with fresh water, let it air-dry and then lubricate it (see 'Lubrication'). Then switch the machine on again.

Error code	Problem	Cause	Possible solution
		The brew group is not positioned correctly.	Switch off the machine. Remove the brew group and reinsert it. Make sure the two reference signs on the side match before you slide the brew group back into the machine (see 'Reinserting the brew group'). Then switch the machine on again.
05	There is a water circuit problem.	There is air in the water circuit.	Switch off the machine. Make sure you insert the water tank into the machine properly. Check if the water tank compartment is clean and free from coffee beans. Then switch the machine on again.
			Restart the machine by switching it off and on again. Try to dispense 2-3 cups of hot water.
		The AquaClean filter was not prepared well before installation.	Switch off the machine and remove the filter from the water tank. Then switch on the machine again and dispense 2-3 cups of hot water. If this works, prepare the AquaClean filter for installation (see separate quick start guide) and reinsert it in the water tank. If again error code 05 appears on the display, the filter needs to be replaced.
14	The machine is overheated.	This can have several causes.	Switch the machine off and switch it back on again after 30 minutes.

## Troubleshooting

This chapter summarizes the most common problems you could encounter with the machine. Support videos and a complete list of frequently asked questions are available on [www.philips.com/coffee-care](http://www.philips.com/coffee-care). If you are unable to solve the problem, contact the Consumer Care Center in your country. For contact details, see the warranty leaflet.

Problem	Cause	Solution
The machine does not switch on.	The machine is disconnected or the main switch is in the 'off' position (0).	Check if the mains cord is inserted correctly.
		Make sure the main switch is set to 'on' position (I).
The machine is in DEMO mode.	You pressed the standby button for more than 8 seconds.	Switch the machine off and then on again with the main switch on the back of the machine.

<b>Problem</b>	<b>Cause</b>	<b>Solution</b>
The drip tray fills up quickly.	This is normal. The machine uses water to rinse the internal circuit and brew group. Some water flows through the internal system directly into the drip tray.	Empty the drip tray when the 'drip tray full' indicator pops up through the drip tray cover. Place a cup under the dispensing spout to collect rinsing water.
The 'coffee grounds container full' icon remains displayed.	You emptied the coffee grounds container while the machine was switched off.	Always empty the coffee grounds container while the machine is switched on. If you empty the coffee grounds container when the machine is switched off, the coffee cycle counter is not reset.
	You placed back the coffee grounds container too fast.	Do not place back the coffee grounds container until the display message prompts you to put it back.
I cannot remove the brew group.	The brew group is not in the correct position.	Close the service door. Switch the machine off and back on again. Wait for the 'machine ready' screen to appear and then remove the brew group.
	You have not removed the coffee grounds container.	Remove the coffee grounds container before you remove the brew group.
I cannot insert the brew group.	The brew group is not in the correct position.	Reset the machine in the following way: place the drip tray and the coffee grounds container back. Leave the brew group out. Close the service door and switch the machine on and off. Then put the brew group in the correct position (see 'Reinserting the brew group') and reinsert it in the machine.
	The machine is still in the descaling procedure.	You cannot remove the brew group when the descaling procedure is in progress. First complete the descaling procedure and then remove the brew group.
The coffee is watery.	The grinder is set to a too coarse setting.	Adjust the grinder to a finer setting.
	The coffee exit duct is clogged.	Clean the coffee exit duct with the handle of the measuring spoon or a spoon handle. Then switch the appliance off and on again.
	The machine is performing its self-adjustment procedure.	Brew a few cups of coffee.
	The brew group is dirty or needs to be lubricated.	Clean and lubricate the brew group.
Coffee is leaking from the coffee dispensing spout.	The coffee dispensing spout is clogged.	Clean the coffee dispensing spout and its holes with a pipe cleaner.

## 22 English

<b>Problem</b>	<b>Cause</b>	<b>Solution</b>
	The coffee exit duct is clogged.	Clean the coffee exit duct with the handle of the measuring spoon or a spoon handle. Then switch the appliance off and on again.
The coffee is not hot enough.	The cups you use are cold.	Preheat the cups by rinsing them with hot water.
	The temperature is set too low. Check the menu settings.	Set the temperature to 'high' in the menu.
	You added milk.	Whether the milk you add is warm or cold, it always decreases the temperature of the coffee to some extent.
The machine does not grind the coffee beans.	The coffee exit duct is clogged.	Clean the coffee exit duct with the handle of the measuring spoon or a spoon handle. Switch the appliance off and on again.
The machine grinds the coffee beans, but coffee does not come out or coffee comes out slowly.	The coffee exit duct is blocked.	Clean the coffee exit duct with the handle of the measuring spoon or a spoon handle. Switch the appliance off and on again.
	The AquaClean filter was not prepared well for installation.	Switch off the machine and remove the filter from the water tank. Immerse the filter upside down in a jug with cold water and wait until no more air bubbles come out. Place back the filter in the water tank, restart the machine and dispense 2-3 cups of hot water.
	The grinder is set to a too fine setting.	Adjust the grinder to a coarser setting.
	The brew group is dirty.	Clean the brew group.
	The coffee dispensing spout is dirty.	Clean the coffee dispensing spout and its holes with a pipe cleaner.
	The machine circuit is blocked by limescale.	Descale the machine.
The milk does not froth.	The classic milk frother is dirty or not assembled correctly.	Clean the classic milk frother and make sure it is correctly assembled that you position and insert it correctly.
	The type of milk used is not suitable for frothing.	Different types of milk result in different amounts of froth and different froth qualities. We have tested the following milk types which proved to deliver a good milk froth result: semi-skimmed or full-fat cow's milk, soy milk and lactose-free milk.

<b>Problem</b>	<b>Cause</b>	<b>Solution</b>
There is water under the machine.	The drip tray is too full and has overflowed.	Empty the drip tray when the 'drip tray full' indicator pops up through the drip tray. Always empty the drip tray before you start descaling the machine.
	The machine is not placed on a horizontal surface.	Place the machine on a horizontal surface so that the 'drip tray full' indicator works properly.
I cannot activate the AquaClean filter and the machine asks for descaling.	You have already replaced the AquaClean filter 8 times.	Descalcify your machine first and install the AquaClean filter. Always activate the AquaClean filter in the menu (see 'Activating the AquaClean filter'). Also do this when you replace the filter.
	The filter has not been replaced in time after the AquaClean filter icon flashed and the capacity dropped to 0%.	Descalcify your machine first and then install the AquaClean filter.
	You did not install the AquaClean filter during first installation, but after having brewed approx. 50 coffees (based on 100ml cups). The machine has to be completely limescale-free before you install the AquaClean filter.	First descale the machine and then install a new AquaClean filter. After descaling, the filter counter is reset to 0/8. Always confirm filter activation in the machine menu. Also do this after filter replacement.
	You did not activate the new or replaced AquaClean filter in the machine menu.	Descalcify your machine first. Then activate the AquaClean filter in the menu (see 'Activating the AquaClean filter'). Also do this when you replace the filter.
The AquaClean filter icon does not appear on the display after I replaced the filter.	You did not confirm activation in the machine menu.	Confirm the activation of the filter in the machine menu. (see 'Activating the AquaClean filter') If the display shows 'START CALC CLEAN', you first need to descale the machine. Remove the AquaClean filter before descaling and reinsert it afterwards.
The AquaClean filter is installed, but the descaling message appears.	You have not activated the AquaClean filter in the machine menu.	First descale the machine and then install a new AquaClean filter. This will reset the filter counter to 0/8. Always confirm filter activation in the machine menu (see 'Activating the AquaClean filter'), also after filter replacement.
The new water filter does not fit.	You are trying to install another filter than the AquaClean filter.	Only the AquaClean filter fits into the machine.





[www.philips.com/coffee-care](http://www.philips.com/coffee-care)



421946037701



>75% recycled paper