

GAGGIA

MILANO



ENGLISH

NEDERLANDS

POLSKI

GAGGIA MAGENTA

MILK

RI8701 (SUP 051P)

Operating instructions
Gebruiksaanwijzing
Instrukcja obsługi

CE



02

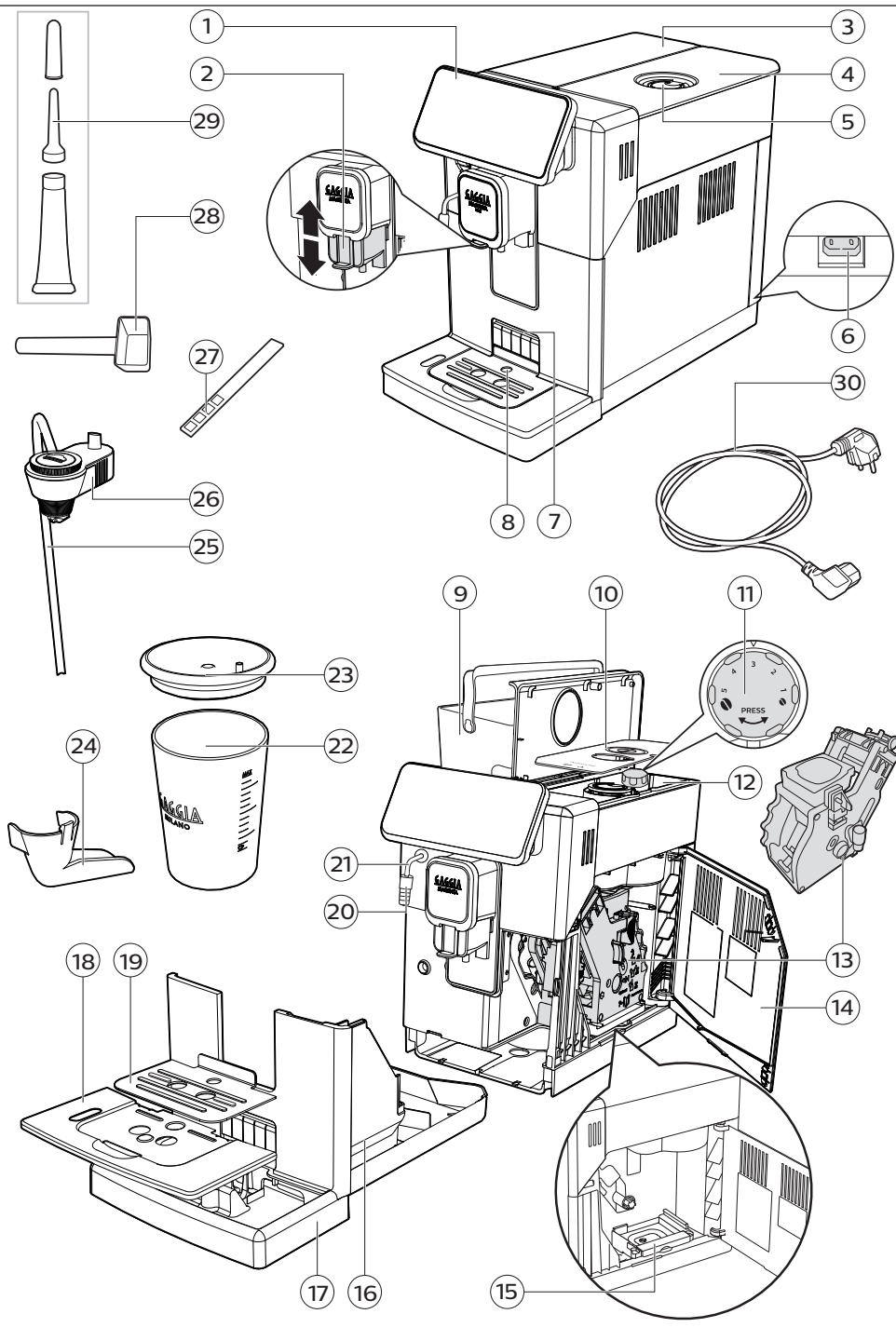



ENGLISH

Congratulations on your purchase of Gaggia Magenta Milk!
This easy-to-use machine guarantees excellent results every day.
Thanks to the intuitive interface, you can choose among 9 beverages and customise them according to your preferences.
Before being packed, each of our high-quality machines undergoes rigorous testing in our laboratories in order to ensure its correct operation. Some coffee residue might be found in your machine, since real coffee is normally used during testing. However, this does not compromise the integrity of the product. Please be assured that this is a brand new machine.
In this user manual you will find all the information you need to install, use, clean and descale your machine. Before using it for the first time, please read carefully the safety manual provided separately and store it for future use.

NEDERLANDS

Van harte gelukgewenst met de aanschaf van een Gaggia Magenta Milk!
Met deze machine zal u op eenvoudige wijze steeds uitstekende resultaten verkrijgen.
Dankzij de intuïtieve interface kan u kiezen uit 9 drankjes en deze naar uw voorkeur aanpassen.
Alvorens verpakt te worden, ondergaat elke machine strenge tests in onze laboratoria om de hoge kwaliteit en correcte werking ervan te garanderen. Er wordt ook tijdens het testen koffie gebruikt, dus het is mogelijk dat er wat residu achterblijft. Dit doet geen afbreuk aan de integriteit van het product: het is een volledig nieuwe machine.
In deze handleiding zult u alle nodige informatie vinden om uw machine te installeren, te gebruiken, schoon te maken en te ontkalken. Lees de aparte veiligheidsbrochure zorgvuldig door voordat u ze voor het eerst gebruikt en bewaar deze voor toekomstig gebruik.

POLSKI

Gratulujemy zakupu urządzenia Gaggia Cadorna Milk!
Dzięki temu urządzeniu zawsze będziesz cieszyć się doskonałymi rezultatami, o które w tym przypadku nie trudno.
Intuicyjny interfejs pozwoli Ci na wybór spośród 9 napojów i dostosowanie ich do Twoich preferencji.
Przed zapakowaniem każde urządzenie przechodzi szereg rygorystycznych testów w naszych laboratoriach, aby zapewnić ich wysoką jakość i prawidłowe działanie. Podczas odbioru urządzenia testujemy je przy użyciu kawy, dlatego mogą pozostać w nim jej pozostałości. Nie wpływa to jednak na integralność produktu: jest to urządzenie całkowicie nowe.
W niniejszej instrukcji zawarto wszelkie informacje niezbędne do zainstalowania, użytkowania, czyszczenia i odwapniania urządzenia. Przed jego pierwszym użyciem zapoznaj się uważnie z dostarczoną osobno broszurą dotyczącą bezpieczeństwa i zachowaj ją w razie potrzeby skorzystania z niej w przyszłości.



First installation / Eerste installatie / Pierwsza instalacja

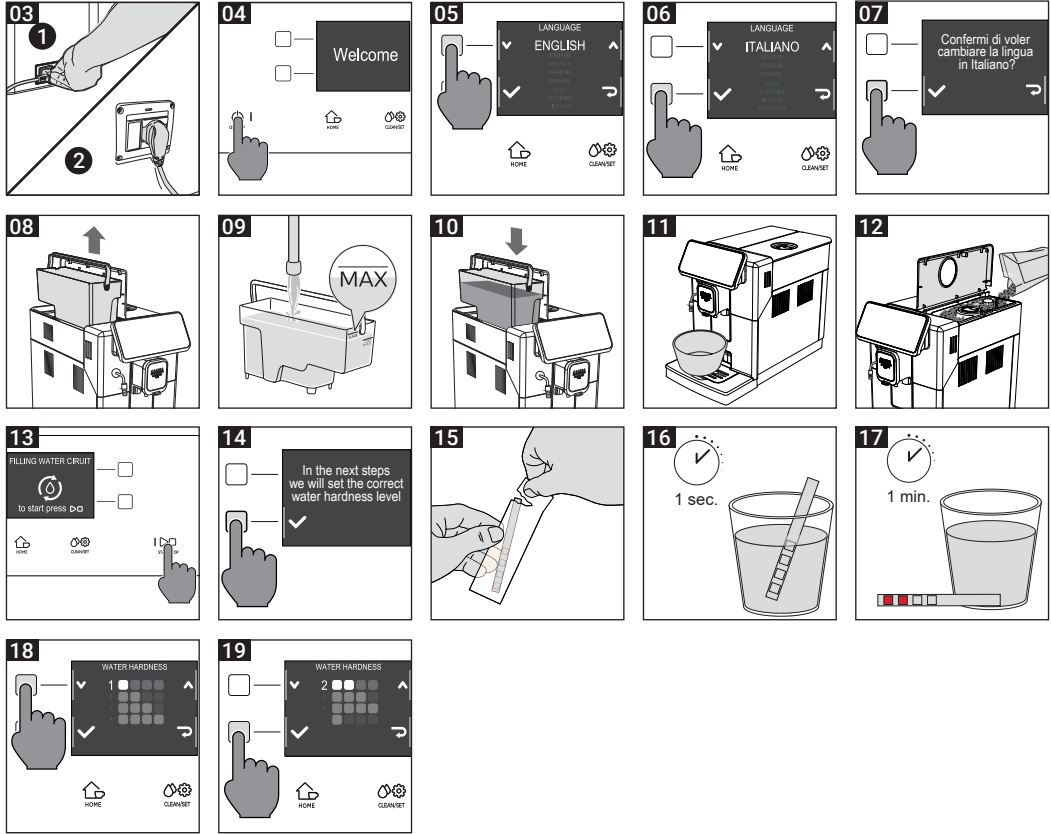

Capp in Cup System / Capp in Cup-system / System Capp in Cup

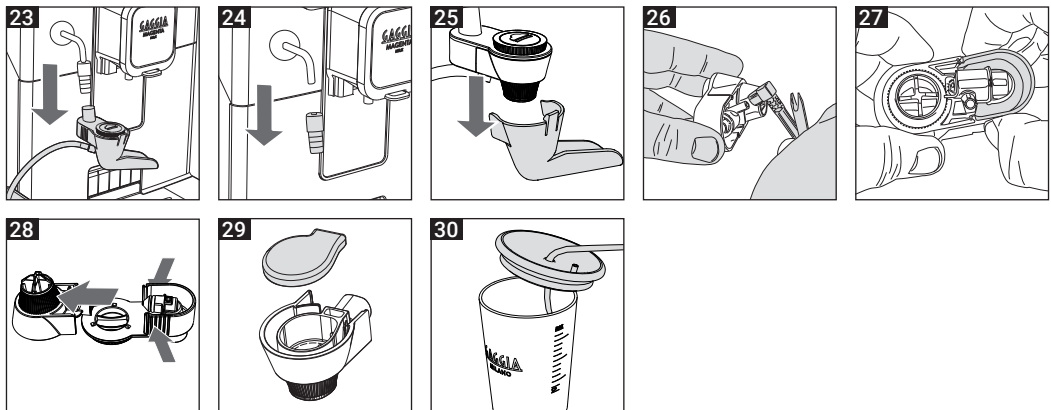

Contents

Machine overview (Fig.2)	6
Control panel and display	7
Control panel overview (Fig. 1)	7
Multifunction buttons	7
First installation	8
Manual rinse cycle	8
Measuring water hardness	9
INTENZA+ water filter	9
Installing the INTENZA+ water filter	10
Replacing the INTENZA+ water filter	10
Types of beverage	11
Espresso tray	12
Coffee Brewing	12
Brewing coffee using coffee beans	12
Brewing coffee using pre-ground coffee	13
Preparation of coffee-based beverages and frothed milk	14
How to assemble the Capp in Cup system	14
Brewing coffee-based and frothed milk beverages	14
Dispensing hot water	15
Customising beverages and saving settings (MEMO)	16
Beverage Customisation	16
Coffee grind settings	17
Cleaning and maintenance	18
Cleaning table	18
Cleaning the Capp in Cup system	20
Cleaning the brew group	21
Lubricating the brew group	23
Descaling	24
Descaling procedure	24
What to do if the descaling process is interrupted	25
Other settings	26
Language	26
Water filter	26
Stand-by Time	26
Units	27
Water hardness	27
Beverage counter	27
Button sound	27
Factory settings	27
Error code key	28
Troubleshooting	29
GAGGIA accessories	32
Technical specifications	32



Machine overview (Fig.2)

1	Control panel	16	Coffee pucks container
2	Adjustable coffee dispensing spout	17	Drip tray
3	Water tank lid	18	Drip tray grid
4	Coffee bean container lid	19	Espresso tray
5	Pre-ground coffee compartment	20	Capp in Cup system handle
6	Power cord socket	21	Steam tube
7	Espresso tray insertion slot	22	Glass milk carafe
8	Full drip tray indicator	23	Glass milk carafe lid
9	Water tank	24	Capp in Cup system Spout
10	Aroma lid	25	Milk suction tube
11	Coffee grinder adjustment knob	26	Main body of Capp in Cup system
12	Coffee bean container	27	Water hardness tester
13	Brew group	28	Pre-ground coffee measuring scoop
14	Service door	29	Lubricant
15	Coffee residues drawer	30	Power cord



Control panel and display

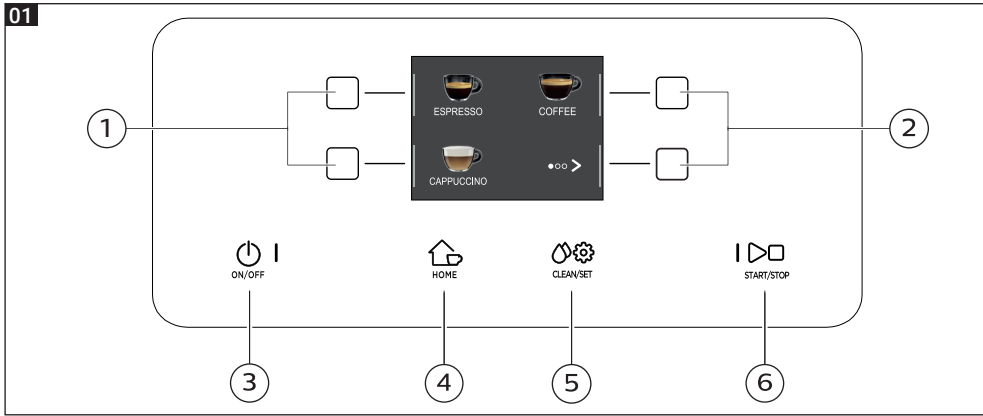

Control panel overview (Fig. 1)

1/2	MULTIFUNCTION buttons	Select the function shown on the display.
3	ON/OFF button	To switch the machine on or off, by keeping the button pressed for a few seconds.
4	HOME button	To open the beverage menu.
5	CLEAN/SET button	To open the cleaning and settings menu.
6	START/STOP button	To start/stop the dispensing of the selected beverage, or to start/stop the procedure indicated on the display.

Note: HOME and CLEAN/SET also work as ESC buttons. You can exit the screen by pressing one of the two buttons to go back to the main menu. This will not be possible if you have already accessed a function or a programme.

Multifunction buttons

The multifunction buttons on the sides of the display are used to select the function or the beverage to which they refer at that time.



Note: To make the reading of this manual easier, <<press the " " button>> means <<press the button related to " " >>.

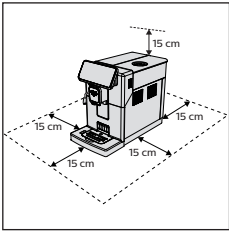

First installation

Before using the machine, it is essential to follow a few simple steps, clearly described in the explanatory drawings you found in the quick guide at the beginning of this instruction manual.

Note: for even tastier coffee, we recommend that you initially prepare 5 cups of coffee to allow the machine to self-adjust.

Manual rinse cycle

During the first installation or after a long period of machine inactivity, a manual rinse cycle must be carried out.

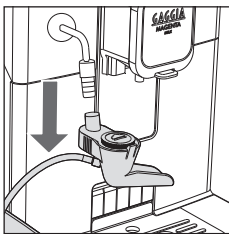
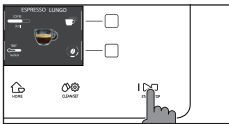

- 1 Place a container under the coffee dispensing spout, scroll through the different pages and select a "ESPRESSO LUNGO".
- 2 Press the "☉" button until "☉" is selected, without adding pre-ground coffee.
- 3 Press the **START/STOP** button to start dispensing. The machine will dispense hot water.
- 4 Empty the container and remove the Cappuccino Cup system from the steam tube.
- 5 Place the container under the steam tube and select "HOT WATER".
- 6 Press the **START/STOP** button to start dispensing.
- 7 Empty the container and repeat steps 5 to 7 until the water tank is empty.
- 8 When finished, refill the water tank to the MAX level. The machine is now ready for use.

Measuring water hardness

You will need to set the water hardness when you install your machine. Take the water hardness measuring strip contained in the packaging and follow the steps shown on the display during the installation phase. To change the water hardness later, press the **CLEAN/SET** button, then select "SETTINGS", and once in the settings menu, please select "WATER HARDNESS".

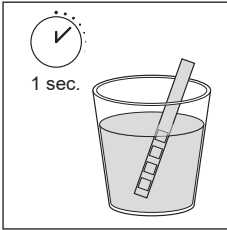

- 1 Immerse the water hardness measuring strip in a glass of water for 1 second. Remove the strip from the water and wait 1 minute.
- 2 Note how many squares turn red.
- 3 Use the green "✓" and "∧" buttons to select the water hardness according to the table below. Confirm the setting by pressing "✓".

Small red squares	Value to set	Water hardness	INTENZA+
■ □ □ □	1	very soft water	A
■ ■ □ □	2	soft water	A
■ ■ ■ □	3	hard water	B
■ ■ ■ ■	4	very hard water	C

INTENZA+ water filter

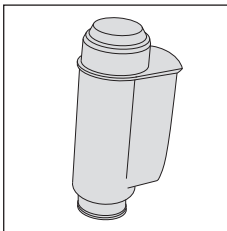

We recommend using the INTENZA+ water filter to limit limescale formation. This ensures a longer operating life of your machine and a better coffee aroma over time.

Water is an essential element in brewing coffee. Therefore, it is extremely important that water is always filtered adequately.

The INTENZA+ water filter prevents the formation of mineral deposits, improving the quality of the water.



Installing the INTENZA+ water filter

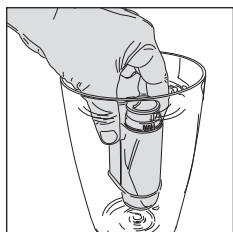

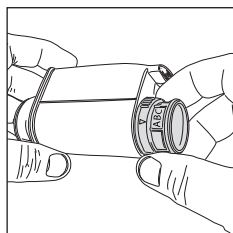

Immerse the INTENZA+ water filter in cold water, in a vertical position and with the opening facing upwards. Press both sides of the filter gently to let air bubbles out.







Remove the INTENZA+ water filter from the water. Set the machine according to the detected water hardness - see the "Measuring water hardness" chapter. On the filter base, please set one of the following:

- A = soft water – 1 or 2 small squares
- B = hard water (standard) – 3 small squares
- C = very hard water – 4 small squares

Place the INTENZA+ filter in the water tank, ensuring it is correctly positioned. Refill the water tank and place it back in its housing.



- 1 Press the **CLEAN/SET**   button and then the "SETTINGS" button.
- 2 Select "WATER FILTER" and press the "✓" button.
- 3 Select "ACTIVATE" and follow the instructions on the display to activate the filter correctly.

Note: you can pause the filter activation procedure by pressing the **START/STOP**   button. To resume the filter activation procedure, press the **START/STOP**   button again.

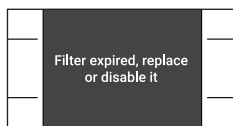
Replacing the INTENZA+ water filter



When the INTENZA+ water filter expires, the warning message appears on the display.

- 1 Replacement or deactivation can be executed by pressing the **CLEAN/SET**   button and then the "SETTINGS" button.
- 2 Select "WATER FILTER" then press the "✓" button.
- 3 **Select** "REPLACE" to change the filter or "DISABLE" if you do not intend to use the filter. Confirm with the "✓" button.

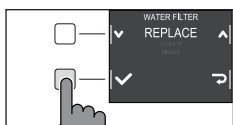









Follow the instructions shown on the display to activate the filter.





Types of beverage

Original recipe	Description
<p>Ristretto</p>  <p>Coffee 30 ml</p>	<p>A ristretto, served in a small cup, is an espresso whose brewing time is shorter than a regular espresso. This results in a coffee that is shorter and less in rich in caffeine.</p>
<p>Espresso</p>  <p>Coffee 40 ml</p>	<p>The espresso is known around the globe as true Italian coffee. Served in a small cup, its unmistakable features are a full and intense aroma and a top layer of compact, natural "crema". It is the result of the pressurized hot water extraction process invented by Achille Gaggia in 1938.</p>
<p>Espresso lungo</p>  <p>Coffee 80 ml</p>	<p>The long espresso is an espresso with a longer extraction time. It is more diluted, with a different aromatic intensity and a higher caffeine content. It is served in a medium-sized cup.</p>
<p>Coffee</p>  <p>Coffee 120 ml</p>	<p>Coffee is a beverage prepared with more water than espresso. It has a lighter aroma and is served in a medium-large cup.</p>
<p>American coffee</p>  <p>Coffee 40 ml Water 110 ml</p>	<p>American coffee is a less intense long coffee, prepared with an espresso to which hot water is added.</p>
<p>Cappuccino</p>  <p>Milk 120 ml Coffee 40 ml</p>	<p>The cappuccino is an Italian classic, among the most loved in the world. It is prepared with espresso, milk and a milk froth, which must be no less than 1 cm thick. It is served in a large cup.</p>
<p>Café au lait</p>  <p>Coffee 90 ml Milk 90 ml</p>	<p>A café au lait is a beverage composed of equal parts coffee and milk. This can even be enriched by a thin layer of milk froth. It is served in a large cup.</p>
<p>Frothed milk</p>  <p>Milk 180 ml</p>	<p>Frothed milk is used to make cappuccinos, latte macchiatos and several other beverages. The result is a compact, homogeneous layer of milk froth.</p>
<p>Hot water</p>  <p>Water 150 ml</p>	<p>Hot water can be used to prepare hot teas, infusions and instant beverages.</p>

Note: In the original recipes the beverages are all set to an average temperature and aroma intensity.



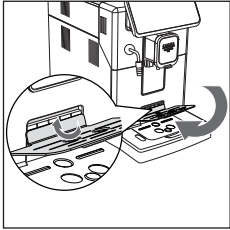
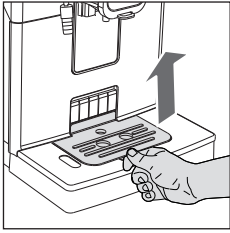

Espresso tray

This machine was designed to guarantee flawless results, from a traditional espresso to a number of different beverages. If you want to enjoy an Italian espresso with a delicious layer of its natural "crema" on top and as tradition dictates, we suggest your using of the "Espresso Tray" which is specifically designed for this purpose. This tray allows the use of traditional espresso cups, ensuring the perfect height for a compact, homogeneous "crema" and a splash-free brewing.

Lift the espresso tray off the grid of the drip tray and place it into the dedicated slot as shown in the drawing.

Coffee Brewing

Brewing coffee using coffee beans

Warning: only use coffee beans when making espresso. Do not put any pre-ground, unroasted, freeze-dried or instant coffee in the coffee bean container, as they may damage the machine.

Tip: Preheat the cups with hot water to enjoy a warmer coffee.

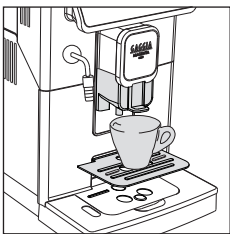

- 1 Upon positioning the espresso tray, place a cup under the coffee dispensing spout, raise or lower the coffee dispensing spout according to the size of the cup you are using.
Press the **HOME**  button to access the beverage menu.



- 2 Browse the various pages to find and select the desired coffee.



- 3 Upon selection of your desired coffee, it is possible to prepare two cups at the same time- besides AMERICANO, using the "" button.

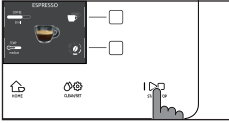

- 4 Finally, press the **START/STOP**  button to start brewing.

Note: you can interrupt the brewing at any time by pressing the **START/STOP**  button.

If you wish to customise the settings of a specific beverage, please refer to the “Beverage customisation” chapter.

Brewing coffee using pre-ground coffee

Use the measuring scoop provided to insert the correct dose in the pre-ground coffee compartment.

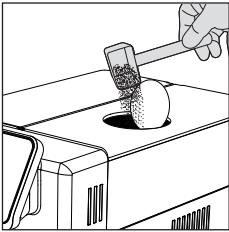

- 1 Lift the lid of the pre-ground coffee compartment and add a little less than one level scoop of pre-ground coffee.

Warning: do not insert anything other than pre-ground coffee, as it may damage the machine.

- 2 Place a cup under the coffee dispensing spout and select the desired beverage.

- 3 Press the “” button until “” is selected.

Note: The “pre-ground coffee” function excludes the possibility of brewing two cups of coffee at the same time, as well as the aroma setting. In fact, these are only possible with coffee beans.

- 4 Press the **START/STOP**  button to start brewing the coffee.

If you wish to customise the settings of a specific beverage, please refer to the “Beverage customisation” chapter.

Note: you can interrupt the brewing at any time by pressing the **START/STOP**  button.

Preparation of coffee-based beverages and frothed milk

How to assemble the Capp in Cup system

Note: Before preparing any milk-based beverage, make sure that the Capp in Cup system is fitted properly on the machine.

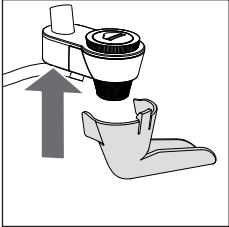

- 1 Fit the spout on the main body of the Capp in Cup system.

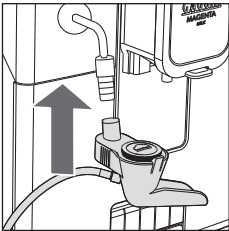

- 2 Insert the Capp in Cup system into the rubber grip on the steam tube until it locks into place.

Brewing coffee-based and frothed milk beverages

Tip: use only cold milk at a temperature of 5 °C approx. and with at least a 3% protein content so as to obtain a perfect milk froth. You can use either whole milk or semi-skimmed milk. Also, you can use skimmed, soy or lactose-free milk.

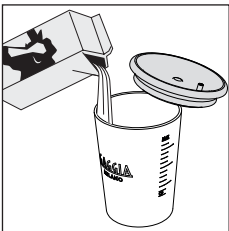

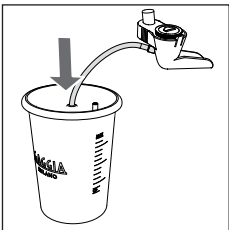

- 1 Lift the carafe lid and pour the milk into the carafe: the milk must reach a level between the minimum (MIN) and the maximum (MAX) level marks available on the carafe.



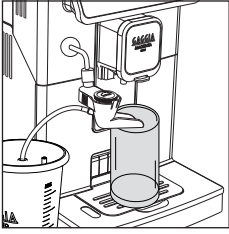

- 2 Insert the suction tube of the main body of the Capp in Cup system into the milk carafe until it reaches the carafe bottom.

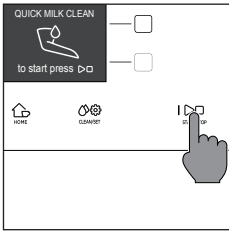

- 3 Place a cup or a glass under the Coffee dispensing spout and the Capp in Cup system.
- 4 Press the **HOME**  button and choose the desired beverage from the menu.
 - Press the button corresponding to the desired beverage.
 - Press the **START/STOP**  button to start dispensing the selected beverage.
- 5 The machine dispenses a default amount of coffee and frothed milk into the cup or the glass. Depending on the beverage chosen, either coffee or frothed milk will be dispensed first.

If you wish to customise the settings of a specific beverage, please refer to the "Beverage customisation" chapter.



- 6 After dispensing your coffee-based and frothed milk beverages, it is best to complete the quick cleaning procedure of the milk circuit within 10 seconds. However, the procedure can also be carried out later by accessing the cleaning menu via the **CLEAN/SET**  button. Press the "CLEAN" button and select the "QUICK CLEAN" option. Then press the "✓" button. Then, follow the instructions shown on the display.

Note: We suggest that you carry out a quick clean at least once a day and that you rinse the Capp in Cup system Spout under running water.

Press the **START/STOP**  button to confirm, or  to carry out the procedure later.

Dispensing hot water

Warning: when preparation starts, the steam tube may spray steam and hot water.

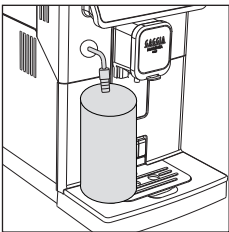

- 1 Remove the Capp in Cup system and place a container under the steam tube.
- 2 Press the **HOME**  button, browse the various screens using the green **">"** button, and select hot water.



- 3 Press the "HOT WATER" button. Finally, press the **START/STOP** button to commence dispensing.

Note: you can interrupt dispensing at any time by pressing the **START/STOP** button.

If you wish to customise the settings of a specific beverage, please refer to the "Beverage Customisation" chapter.

Customising beverages and saving settings (MEMO)

This machine allows you to change the settings of a beverage according to your preferences and save them (MEMO), by overwriting the previous settings.

Beverage Customisation

- 1 Press the **HOME** button.
- 2 Select your beverage.
- 3 All the settings that can be adjusted and/or selected are displayed on the screen. Based on the type of beverage, you can adjust and/or select:
 - coffee and milk amount;
 - coffee temperature;
 - brewing two cups at a time;
 - pre-ground coffee use;
 - aroma intensity (only when using coffee beans);
- 4 Once the "COFFEE" or "MILK" button has been pressed, use the green "+" and "-" buttons to select the desired amount. Press "✓" to confirm and return to the previous screen, where the new quantity will be displayed.
- 5 Press the "TEMP" button repeatedly to adjust the temperature of the beverage among the following options:
 - low;
 - medium;
 - high;
- 6 Press "☺" button to brew two cups, or "☹" for a single cup. The picture of the beverage in the centre of the display will indicate the number of cups selected.

Note: this function is not available for beverages with milk, AMERICANO and HOT WATER.



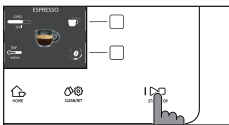
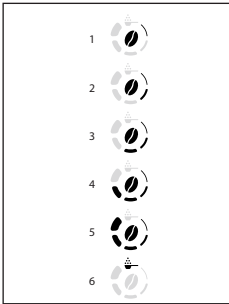

- 8 To change the intensity of the aroma or select the pre-ground, press the "☉" button. You can choose among 5 different degrees of intensity. Every time you press the "☉" button, the aroma strength changes by one degree. The display shows the selected intensity or the selection of the pre-ground.
- 1 Very light
 - 2 Light
 - 3 Normal
 - 4 Strong
 - 5 Very strong
 - 6 Pre-ground.

Note: the function Pre-ground allows the brewing of just one coffee at a time.

- 9 Once the beverage has been customised according to your preferences, you can proceed with dispensing it by pressing **START/STOP** > □ button.
- 10 If you have changed any of the parameters listed above, you will be asked at the end of dispensing if you would like to save the recipe with the changes made.

Note: the new saved settings will overwrite those of the previous recipe.

Note: to return to the factory settings of the single recipes, you must re-enter and save the settings indicated in the "Beverage type" section.

Coffee grind settings

You can adjust the grind setting using the grinder adjustment knob on the coffee bean container. The ceramic coffee grinder guarantees a perfect and homogeneous grinding for the preparation of every cup of coffee. The aroma is thus preserved, ensuring the perfect flavour every time.

Note: you can only adjust the grind setting while the machine is grinding the coffee beans. The difference in taste will be perceived after brewing 2-3 cups of coffee.

Warning: to avoid damaging the coffee grinder, do not rotate the grinder adjustment knob more than one notch at a time.

- 1 Place a cup under the coffee dispensing spout.
- 2 Open the lid of the coffee bean container.
- 3 Prepare an espresso as described in the chapter "Brewing coffee with coffee beans".

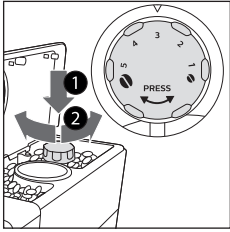

- 4 While the machine is grinding coffee, press the grind settings adjustment knob in the bean container and turn it one notch at a time, to the left or right.
- 5 You can select from 5 different grinding settings. The smaller the notch, the stronger and richer the coffee.

Note:

- Coarse grind: lighter taste, for dark roasted coffee blends (3-5);
- Fine grind: stronger taste, for light roasted coffee blends (1-3);

Cleaning and maintenance

Regular cleaning and maintenance keep the machine in perfect condition and ensure perfect coffee flavour, a constant coffee flow and an excellent milk froth. Please refer to the following table to know when and how to clean the removable parts of the machine. Please read the specific chapter for further information.

Cleaning table

Part description	When to clean	How to clean
Capp in Cup system	After use	Start the " QUICK CLEAN" process following the instructions on the display. Disassemble and wash the Capp in Cup system Spout under running water.
	Daily	Wash the glass milk carafe or place it in your fridge by positioning the milk suction tube as shown in the figure. You can also dishwash it.
	Monthly	Start the "DEEP CLEAN" cycle by following the instructions described in the chapter "Capp in Cup System Cleaning". For this cleaning cycle use the Philips Milk Circuit Cleaner. Remove the Capp in Cup system and wash all its components under running water.

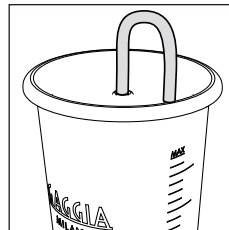

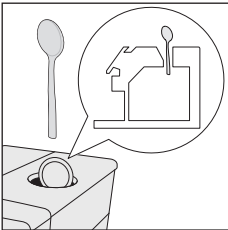
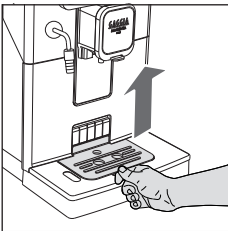

Part description	When to clean	How to clean
Brew group	Weekly	Remove the brew group and clean it under running water.
	Depending on usage	See the "Cleaning and lubricating the brew group" chapter.
	Monthly	Clean the brew group with the Gaggia coffee oil remover to remove any oily coffee residue
Drip tray full	When the red mark appears from the drip tray grid.	Empty the drip tray and clean it under running water.
Coffee pucks container	Whenever the machine requires it	Empty the coffee pucks container and clean it under running water. Ensure that the machine is switched on during this procedure, otherwise the coffee pucks container will not reset.
Water tank	Weekly	Clean it under running water.
Pre-ground coffee compartment/coffee outlet duct	Weekly	Clean the upper part using the handle of a spoon, as shown below. 
Espresso tray	Depending on usage	Remove the espresso tray and clean it with running water. You can also dishwash it in the upper tray. 



Cleaning the Capp in Cup system

Capp in Cup system Cleaning Programmes

The machine allows two cleaning programmes for the Capp in Cup system: quick and deep clean. Both programmes can be selected with the **CLEAN/SET**  button. Press the "CLEANING" button upon selection.

Quick clean is also recommended after dispensing a milk-based beverage. For both programmes, follow the instructions shown on the display.

- Quick clean programme

The quick clean programme includes the milk circuit cleaning with hot water.

- Deep clean programme

The deep clean programme for the Capp in Cup system includes also the deep cleaning of the whole milk circuit by means of Philips "Milk Circuit Cleaner".

Cleaning of the Capp in Cup system under running water

Warning: the steam tube may be hot after use.

- 1 Remove the Capp in Cup system from the steam tube (Fig. 23).
- 2 Remove the rubber handle from the steam tube. (Fig. 24).
- 3 Remove the Capp in Cup system spout (Fig. 25).
- 4 Remove the milk suction tube from the main body of the Capp in Cup system (Fig. 26).
- 5 To disassemble the main body:
 - hold it tight from the sides as shown (Fig. 27);
 - pull and extract the left part as shown in figure (Fig. 28);
- 6 Remove the rubber lid (Fig. 29).
- 7 Disassemble the glass milk carafe (Fig. 30).
- 8 Wash all components under running water.
- 9 After cleaning, reassemble all the components by following the same procedure in reverse order.



Cleaning the brew group

Warning: do not wash the brew group in the dishwasher and do not use dishwashing detergents, since they may cause the malfunctioning of the brew group and alter the coffee flavour.

Removing the brew group

- 1 Turn off the machine and disconnect the power cord.
- 2 Remove the drip tray and the coffee pucks container.
- 3 Open the service door.
- 4 Press the PUSH lever (1) and pull the handle of the brew group (2) to remove it from the machine.

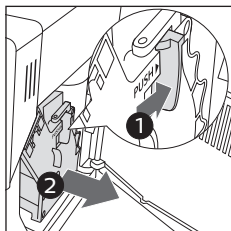

- 5 Remove the coffee residues drawer.

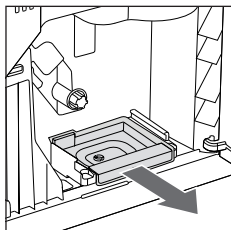

Cleaning the brew group under running water

- 1 Clean the coffee outlet duct thoroughly with a spoon handle or with another round-tipped kitchen utensil.

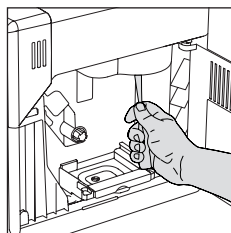

- 2 Rinse the brew group and the coffee residues drawer thoroughly with lukewarm water. Carefully wash the upper filter.
- 3 Let the brew group air dry.

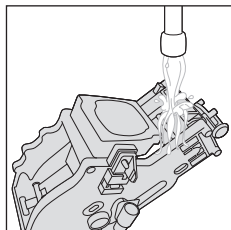

Note: to avoid the build-up of fibres in its interior, do not dry the brew group with cloth.



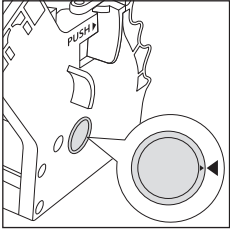

Reinserting the brew group

- 1 Before placing the brew group back into the machine, make sure that the two yellow reference marks on the side match. If this is not the case, perform the following step:

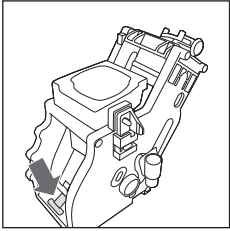

Make sure that the lever is in contact with the base of the brew group.

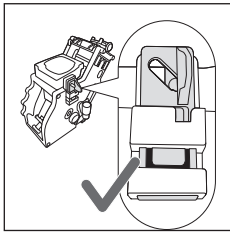

- 2 Make sure that the yellow locking hook of the brew group is in the right position.

To position the hook correctly, push it upwards to the highest possible position.

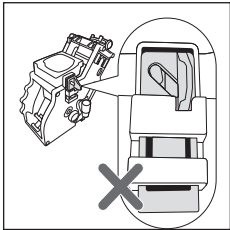

If the hook is still in the lower position, it means that it is not positioned correctly.

- 3 Reinsert the coffee residues drawer.
- 4 Reinsert the brew group into the machine along the side guides until it locks in the right position with a click.

Warning: do not press the PUSH lever.

- 5 Close the service door.



Cleaning the brew group with cleaning tablets for the removal of oily coffee residues

Warning: use only Gaggia cleaning tablets to remove oily coffee residues.

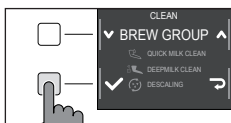

- 1 Place a container under the coffee dispensing spout.



- 2 Press the **CLEAN/SET**  button and select the "CLEAN " button shown on the display.
- 3 Select "BREW GROUP CLEANING" and press the "✓" button, then press **START/STOP**  button to start the cleaning procedure.
- 4 Follow the instructions shown on the display to clean the brew group correctly.
- 5 The procedure will take approximately 5 minutes. **START/STOP**  button can be used to pause and resume the procedure.

Lubricating the brew group

In order to ensure the perfect performance of the machine, it is necessary to lubricate the brew group. Refer to the following table for the frequency of lubrication.

Frequency of use	Number of beverages prepared daily	Lubrication frequency
Low	1-5	Every 4 months
Regular	6-10	Every 2 months
High	>10	Every month

- 1 Turn off the appliance and disconnect the power cord.
- 2 Remove the brew group and rinse it using lukewarm water - see the "Cleaning the brew group under running water" chapter.
- 3 Apply a thin layer of the lubricant provided around the insertion pin on the lower part of the brew group.

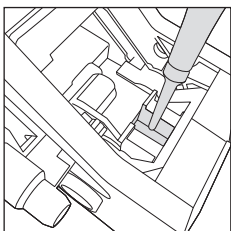

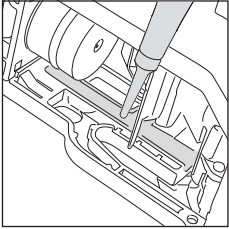
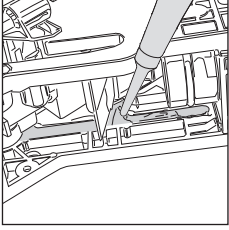

- 4 Apply a thin layer of lubricant to the guides, on both sides (see figure).
- 5 Reinsert the brew group - see the "Reinserting the brew group" chapter.

Note: you can use the lubricant tube multiple times.



Descaling

Descaling procedure

Descaling needs to be carried out when the machine requires it.

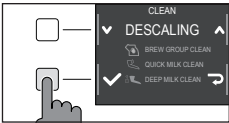
Use only Gaggia descaling solution designed to guarantee the machine's excellent performance. The use of different products could damage the machine and leave residue in the water. Failure to descale the machine will void the warranty.



- 1 Remove the Capp in Cup system if fitted on the machine.
- 2 Press **CLEAN/SET**  button and select the "CLEAN " button shown on the display.
 - Select "DESCALING " and after confirming with "✓" press the **START/STOP**  button to start.
- 3 Remove the drip tray and the coffee pucks container, empty and place them all back into the machine.
- 4 Remove the water tank and empty it. Remove the INTENZA+ filter, if in place.

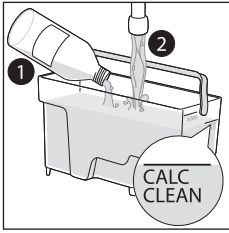

- 5 Pour the entire bottle of Gaggia descaling solution into the water tank and fill the tank with water up to the CALC CLEAN level. Reinsert it into the machine.
- 6 Place a large recipient (1.5l) under the steam tube and the coffee dispensing spout.
- 7 Follow the instructions shown on the display to launch the descaling procedure. This procedure lasts approximately 25 minutes and consists of a descaling cycle and a rinse cycle, carried out with dispensing at regular intervals.
- 8 Once the descaling cycle is complete, rinse the water circuit and tank by following the instructions shown on the display.
- 9 Position the INTENZA+ filter back into the water tank.

Note: it is possible to pause and resume the procedure at any time by pressing the **START/STOP**  button.

Warning: when the descaling procedure is active, the brew group cannot be removed. Wait for the descaling process to end, then remove the brew group.

What to do if the descaling process is interrupted



You can exit the descaling procedure by keeping the **ON/OFF**  button on the control panel, pressed for a few seconds. If the descaling procedure is interrupted before its completion, proceed as follows:

- 1 Empty the water tank and wash it thoroughly.
- 2 Fill the water tank with running water up to the CALC CLEAN level mark, then switch the machine back on. The machine will warm up and perform an automatic rinse cycle.
- 3 Before preparing any beverages, carry out a manual rinse cycle as described in the dedicated chapter.

Note: if the procedure has not been completed, it will be necessary to carry out another descaling procedure as soon as possible.



Other settings

By pressing the **CLEAN/SET**   button and selecting "SETTINGS" on the display, you can reset or modify some of the machine parameters including:

- Language.
- Water filter.
- Stand-by Time.
- Units.
- Water hardness.
- Beverage counter.
- Button sound
- Factory settings.

Language

When the language setting icon is selected, the list of available languages will be displayed.

Available languages

ITALIAN	DANISH	CZECH
ENGLISH	GREEK	SLOVAKE
GERMAN	POLISH	LITHUANIAN
FRENCH	RUSSIAN	JAPANESE
SPANISH	ROMANIAN	KOREAN
PORTUGUESE	HUNGARIAN	TRADITIONAL CHINESE
DUTCH	BULGARIAN	SIMPLIFIED CHINESE

Water filter

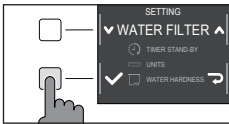

When "WATER FILTER" is selected, follow the instructions on the display and those described under the "Installing the INTENZA+ water filter" and "Replacing the INTENZA+ water filter" chapters.

Stand-by Time

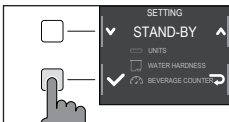

When "STAND-BY TIME" is selected, the timer can be set to:

- 15 min
- 30 min
- 60 min
- 180 min

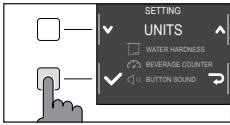

Units

By selecting "UNITS":

you can set the unit of measurement in "ml" or "oz".

Water hardness

With "WATER HARDNESS" selected, follow the instructions on the display and those described under the "Measuring water hardness" chapter.

Beverage counter

It is possible to display the number of cups of each beverage that have been dispensed since the first operation of the machine. These data cannot be reset.

Button sound

You can turn the button sound off by selecting "OFF" so as not to be disturbed.

Factory settings

You can reset the machine to factory default values. The machine will require a double confirmation before proceeding.



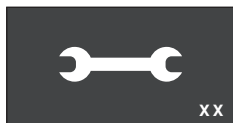

Error code key

The list below reports the error codes that the display can show, their meanings and how to solve the problem. If the indicated solutions are ineffective because the display continues to show the error code icon and the machine does not return to normal operation, or if other error codes are displayed, you must contact an authorized service center or distributors in your country.

The contact info is listed on www.gaggia.com and www.gaggia.it.





Error code	Problem	Cause	Possible solution
01	The coffee grinder is clogged.	The coffee outlet duct is clogged.	Remove the power cord and remove the brew group. Clean the coffee outlet duct thoroughly using a spoon handle. Switch the appliance back on again.
03 - 04	A problem occurred in the brew group.	The brew group is dirty or not well lubricated.	Switch off the machine. Remove the brew group and clean it thoroughly. (Refer to the "Cleaning the Brew Group" chapter)
		The brew group is not positioned correctly.	Switch off the machine. Remove the brew group and reinsert it. Ensure that the brew group is in the correct position before inserting it. Refer to the "Reinserting the brew group" chapter.
05	A problem occurred in the water circuit.	There is air in the water circuit.	Remove and reinsert the tank in the machine a couple of times. Make sure you insert the tank correctly in the machine. Check that the water tank seat is clean.
			If you use an "INTENZA+" filter: pull out the filter from the water tank and shake it to remove the air from the filter. Then place the "INTENZA+" filter back into the water tank.
14	The machine is overheated.	There may be multiple causes.	Switch off the machine and switch it back on again after 30 minutes. Perform this operation 2 or 3 times.

Troubleshooting

This chapter outlines the most common problems you may encounter while using the machine. If you are unable to solve the problem using the information provided below, visit the FAQ sections on www.gaggia.com or www.gaggia.it or contact the either the Customer Service Centre or the local distributors in your country.

Problem	Cause	Solution
The machine does not switch on.	The machine is not connected.	Check that the power cord has been inserted correctly.
	The on / off button was not pressed and held down long enough.	Keep the on / off key pressed for a few seconds.
The drip tray fills up quickly.	It is a normal phenomenon. The machine uses water to rinse the internal circuit and the brew group. Part of the water flows through the internal system directly into the drip tray.	Empty the drip tray when the red mark appears through the grid. We recommend your placing a cup under the dispensing spout to collect rinse water
The display continuously shows the "coffee pucks container full" icon.	The coffee pucks container has been emptied when the machine was off.	Always empty the coffee pucks container when the machine is on. If you empty the coffee pucks container when the machine is off, the coffee cycle counter does not reset. In this case, the display shows the icon even if the container is not full.
	The coffee pucks container has been placed back too quickly.	Always wait about 5 seconds when you replace the coffee pucks container. This way, the counter will reset to zero.
The machine requests to empty the coffee pucks container even if it is not full.	The machine has not reset the counter last time the coffee pucks container has been emptied.	Always wait about 5 seconds when you replace the coffee pucks container. This way, the coffee grounds counter will reset to zero.
		Always empty the coffee pucks container when the machine is on. If you empty the coffee pucks container when the machine is off, the coffee cycle counter does not reset.
The coffee pucks container is too full and the "coffee pucks container full" icon, did not display.	The drip tray has been removed without emptying the coffee pucks container.	When you remove the drip tray, also empty the coffee pucks container even if it contains only a few coffee pucks. In this way the coffee grounds counter will be reset to zero, re-starting to correctly count the coffee pucks.
Impossible to remove the brew group.	The brew group is not in the correct position.	Close the service door. Switch the machine off and then back on. Wait for the display to show the ready message, then remove the brew group.

Problem	Cause	Solution
The brew group cannot be inserted.	The brew group is not in the correct position.	The brew group has not been positioned correctly before being placed back. Ensure that the lever is in contact with the base of the brew group and that the hook of the brew group is in its correct position. See the "Reinserting the brew group" chapter. To reset the machine put the drip tray with the coffee pucks container back in place. Do not insert the brew group. Close the service door, then unplug the power cord and plug it back in. Then try to reinsert the brew group and switch on the machine.
The espresso is not creamy enough or it is watery.	The coffee grinder is set to a coarse grinding.	Adjust the coffee grinder to a finer setting.
	The machine is performing its self-adjustment.	Dispense several cups of coffee so that the machine adjusts itself automatically.
	The coffee outlet duct is clogged.	Clean the coffee outlet duct with a spoon as described in the "Cleaning the brew group under running water" chapter.
The brewed coffee is not hot enough.	The set temperature is too low. Check the menu settings.	Set the menu temperature to "MAX".
The machine grinds the coffee beans, but no brewing happens.	The coffee grinder is set to a too fine grinding.	Adjust the coffee grinder to a coarser grinding.
	The coffee dispensing spout is blocked.	Dispense a long coffee from pre-ground coffee but without actually adding pre-ground coffee.
	The nozzles of the coffee dispensing spout are blocked.	Clean the nozzles of the coffee dispensing spout with a small bottlebrush.
The coffee comes out slowly or in drops.	The coffee grinder is set to a too fine grinding.	Adjust the coffee grinder to a coarser grinding.
	The nozzles of the coffee dispensing spout are blocked.	Clean the nozzles of the coffee dispensing spout with a small bottlebrush.
	The machine circuit is clogged by limescale.	Descale the machine.

Problem	Cause	Solution
The milk does not froth.	The Capp in Cup system is dirty or not correctly inserted. Or, the system has not been correctly installed in all its components.	Clean the Capp in Cup system as indicated in the chapter "Capp in Cup System Deep Cleaning Under Running Water", then place it back in the right way. Make sure all components have been correctly assembled.
	The type of milk used is not suitable for foaming.	The amount and the quality of froth vary depending on the type of milk.
The "INTENZA+" filter cannot be inserted.	Remove the air from the filter.	Let the air bubbles out of the filter.
	The tank still contains some water.	Empty the water tank before installing the filter.
	The rubber seal is not inserted onto the "INTENZA+" filter.	Check the packaging and insert the seal onto the "INTENZA+" filter.
You can not activate the "INTENZA+" filter.	Another filter is already active	The machine indicates the filter usage in percentage. However, if you want to activate a new filter before the one currently in use has expired, the latter must be disabled first and as described in section "Replacing INTENZA+ water filter"
There is some water under the machine.	The drip tray is too full and has spilled over.	Empty the drip tray when the mark appears though the tray. Always empty the drip tray before starting the descaling procedure.
The machine is in DEMO mode.	While switching on the machine, you pressed a combination of buttons (HOME  - CLEAN/SET  - HOME  - CLEAN/SET ).	Switch the machine off and on again, with the ON/OFF  button on the control panel.

GAGGIA accessories

Coffee and accessories are available through authorised centres (Italy), or distributors in your country.



Descaling product



INTENZA+ water filter



Coffee oil remover



Milk circuit cleaner
(Philips)



Coffee range available in beans and powder: 100% Arabica / Intense / Decaffeinated

Technical specifications

Nominal voltage - Power rating - Power supply	See data plate on the inside of the service door
Housing material	Thermoplastic type
Dimensions	224 x 357 x 435 mm
Weight	7,7 kg
Power cord length	1200 mm
Control panel	Front panel
Water tank	1.8 litres - Removable type
Coffee bean container capacity	250 g
Coffee pucks container capacity	15
Pump pressure	15 bar
Boiler	Stainless steel boiler
Safety devices	Thermal Fuse