

STAMPATO SU CARTA RICICLATA. NESSUN ALBERO È STATO ABBATTUTO PER PRODURRE QUESTO MANUALE

Cod. 0317.951 - Ed. 06 03/99

Magic
Superautomatica
de luxe

TYPE SUP 012

- User's and maintenance booklet

 **Saeco** | 

*We congratulate for having bought this top-quality espresso machine and thank you for choosing Saeco.
Before operating the machine, we recommend to read the following instructions thoroughly which explain how to use, clean and maintain the machine.*

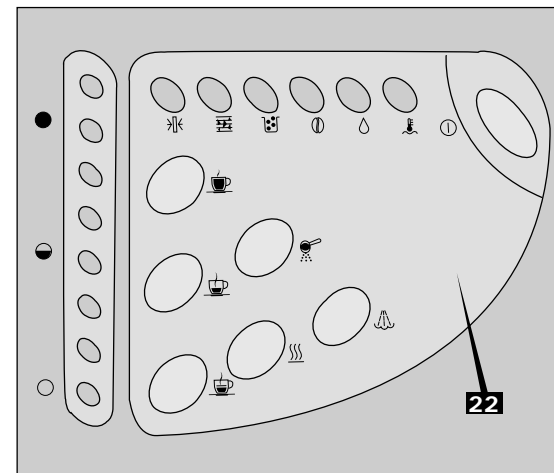
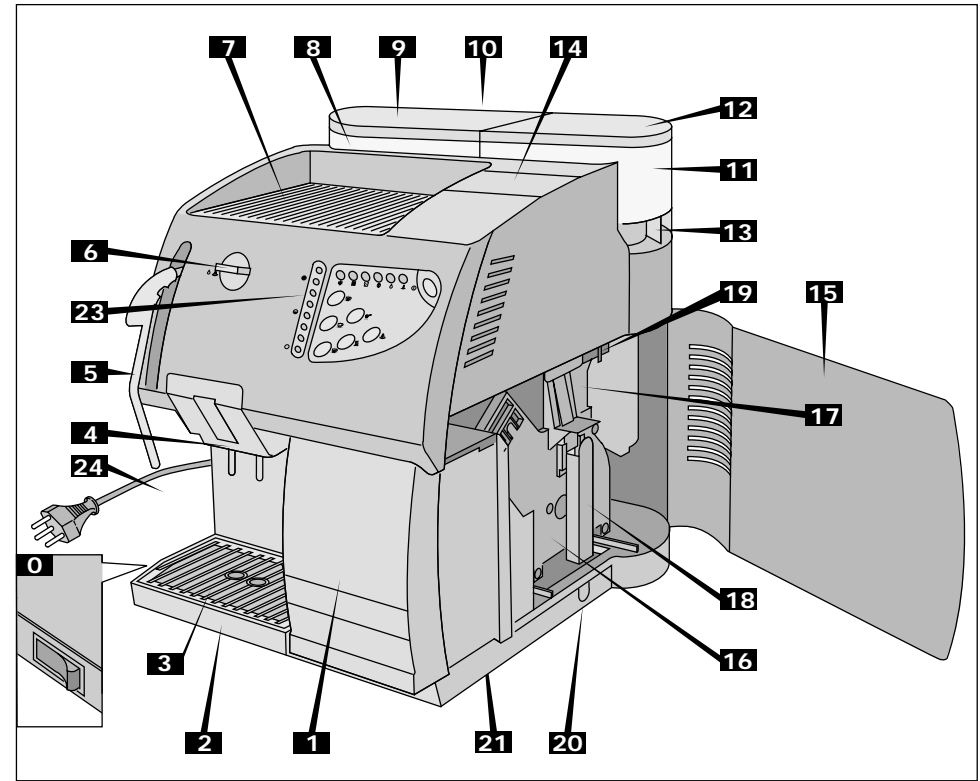

4

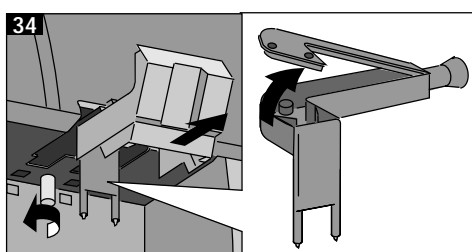
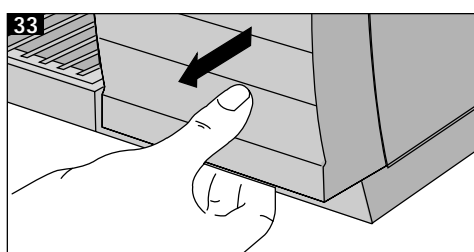
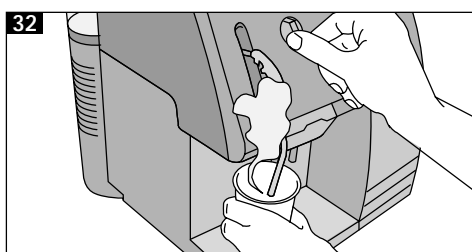
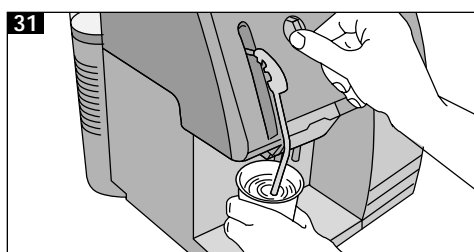
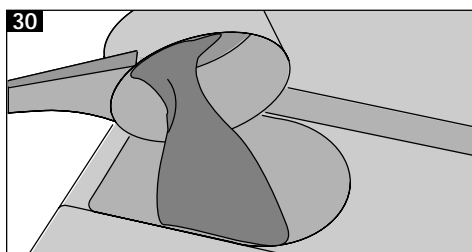
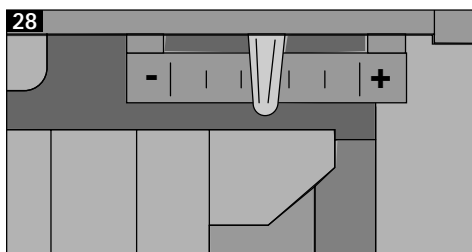
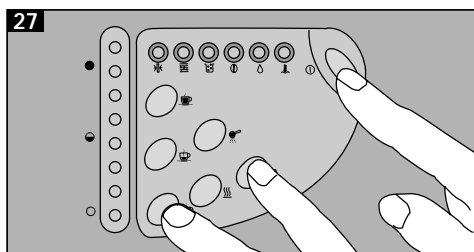
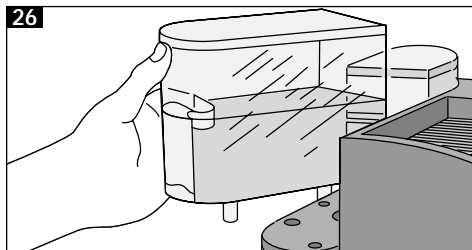
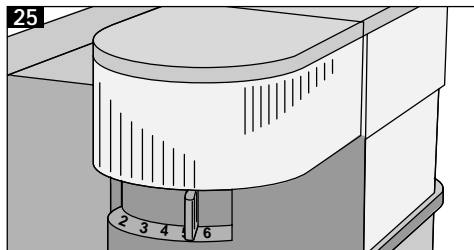

5

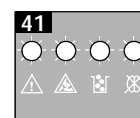
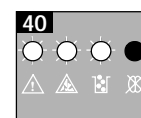
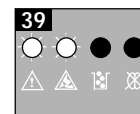
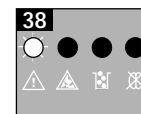
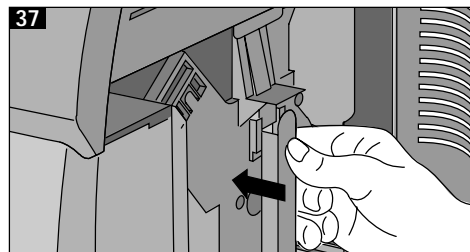
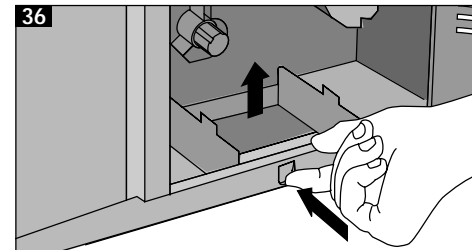
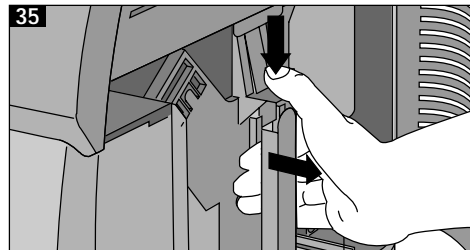



The warning triangle shows all important safety indications to ensure the user's safety. The non-observance of said instructions may cause serious injuries!

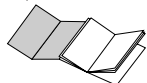

The first cover page of the manual shows figures relevant to the text. Thus, keep it open while reading the instructions.

How to use the instructions

These instructions cannot anticipate every possible use of the machine. For further information or questions concerning specific situations or problems, please contact the local dealer or manufacturer directly.

Table of contents

Page

27	Technical data
27	Safety precautions
28	Controls and machine parts
28	Control panel description
29	Unpacking/Installation
29	Power supply connection
29	Starting and use
30	Drainage

Page

30	Programming the machine
31	Dosage of ground coffee
31	Recommendations
32	Brewing
34	Incorporated Safety Devices
35	Cleaning/Maintenance
38	Disposal
39	Troubleshooting

B

Reference to figures, parts of the machine and control elements are given by numbers or letters, as figure B exemplifies.

Voltage rating	230V/50Hz
Power	1250 W
Dimensions (lengthxwidthxheight)	approx. 385x330x395 mm
Machine case	plastic material ABS/metal
Weight	approx. 1.3 kg
Cable length	approx. 1.2 m
System	free flow thermal cut-out, alternating piston pump
Temperature control	electronic
Coffee grinder adjustment	grinding adjustment device
Coffee grounds ejection	automatic
Ground coffee dosage	coffee releasing device
Cup programming	0–250 cl
Water tank	removable, transparent tank
Water regulation	electronic, continuous
Capacity	– water tank – bean coffee container
Steam/hot water dispensing tube	adjustable, supplied with burn protection
Steam/hot water dispensing	adjustable, continuous
Heating time	approx. 2 min.
Brewing time	– espresso coffee – coffee – hot water – milk
Overheating protection	incorporated
Screened	Ⓢ in accordance with EN55014
Insulation	protection range I
ASE approval	Ⓢ
In compliance with EN rule	60335
Warranty	in compliance with the warranty certificate enclosed herein

Accessories (included in the machine price)

Measuring spoon

Central unit key

Cleaning brush

Water hardness detecting strips

The manufacturer reserves the right to make improvements to the appliance due to technological advancement.

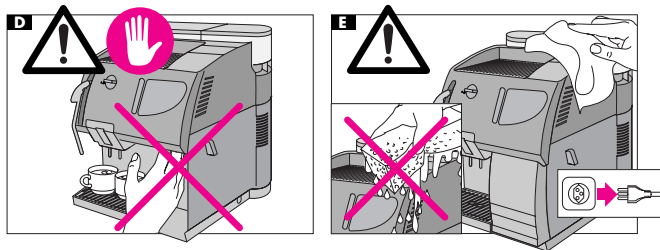
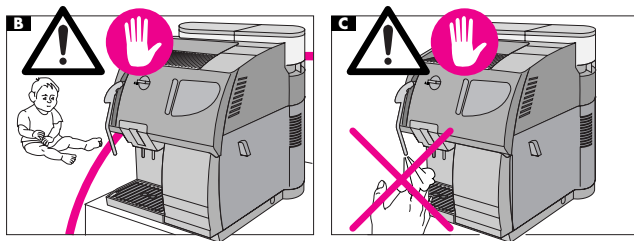
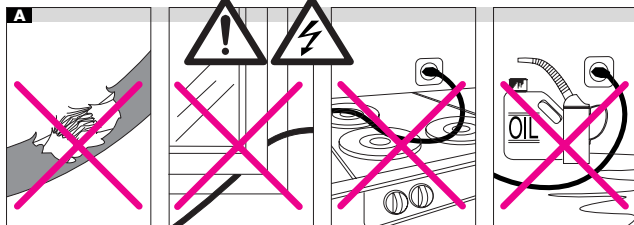

Danger!
Electric voltage may cause death. Electrical parts should never be in contact with water: danger of short-circuit. Overheated steam and hot water may cause burns! Do not direct steam or water jet towards the body; furthermore great attention must be given when touching either the dispensing tube or the heating plate: danger of burns!

■ This machine must be used exclusively for the purpose it has been manufactured. This machine has been manufactured for domestic use only. Do not make technical changes; any improper use is forbidden due to the risks which might occur!

■ Indications

The machine shall only be used by adults and properly instructed persons.

■ Voltage

Never touch parts under current! They might cause electric shocks, serious injuries or death. The automatic coffee machine must be connected to the power supply. Voltage must correspond to the voltage shown on the appliance rating plate.

■ Power cord

Never operate a machine with a defective power cord. Replace defective power cords and plugs, contacting authorised personnel. Do not extend the cable around corners, sharp edges or over hot parts, and protect it from oil.

Do not shift or move the appliance by pulling on its power cord. Do not unplug the machine by pulling the power cord and never touch the cord with wet hands. Make sure the power cord does not hang from tables or shelves.

■ Keep children away

Do not allow children to play with the appliance. Children are not aware of the potential danger of

electric appliances.

■ Positioning

Place the automatic coffee machine in a safe place, where nobody can turn it upside down or be hurt. Hot water or overheated steam might escape from the machine: danger of burns! Never use the coffee machine outdoors. Do not place the machine on hot surfaces or in the proximity of open flames to prevent the case from melting and to avoid other damage.

■ Danger of burns

Do not direct the overheated steam or hot water jet towards you or other people. Do not touch hot surfaces, such as the heating plate. Always use the handles or knobs. Touch spouts only if the heat protectors have been fitted on.

■ Protection of the hands

Never touch the central unit with fingers when brewing coffee: danger of injuries! While operating, the central unit shifts and may thus cause fingers to get trapped in the machine.

■ Cleaning

Before cleaning the machine, make sure to switch off all buttons and unplug the machine. Furthermore, wait until the machine cools down. Never place the machine into water.

Do not tamper with the inner part of the machine and never open the machine.

■ Storage of the machine

When the machine is not being used, turn it off and unplug it. Keep it in a dry place, far from the reach of children.

■ Repair/Maintenance

In case of defect, fault or suspected damage following a fall, unplug the machine immediately. Never use a defective appliance.

Only skilled personnel are authorised to carry out repairs. The manufacturer declines any liability whatsoever, should repairs fail to be carried out by authorised personnel.

- | | |
|--|---|
| <ul style="list-style-type: none"> 1 Coffee grounds container 2 Drip tray 3 Cup holder grill 4 Coffee dispenser (removable) 5 Steam/hot water dispensing tube with heat protector 6 Steam/hot water selection knob 7 Heating plate 8 Water tank 9 Water tank cover 10 Water level 11 Coffee bean container 12 Coffee bean container cover 13 Grind adjustment lever | <ul style="list-style-type: none"> 14 Pre-ground coffee container with cover 15 Service door 16 Central unit 17 Filling funnel 18 Handle for assembling and disassembling of central unit 19 Coffee adjustment lever 20 Coffee rest drawer 21 Swivel (removable) 22 Control panel with warning lights 23 LED warning light showing fill level in cup 24 Power cord |
|--|---|

Control panel description



- | | |
|--|--|
| <ul style="list-style-type: none"> ☐ Central unit warning light
On: the central unit is not correctly mounted
Blinking: the central unit is missing ☐ Descaling warning light:
On: descaling required ☐ Coffee grounds container warning light:
On: the container is full
Blinking: the container has not been properly positioned ⓪ Coffee bean container warning light
On: the coffee grinder is jammed ⚠ Water tank warning light
On: the tank is empty
Blinking: pump is not functioning properly; it must be drained | <ul style="list-style-type: none"> 🌡 Temperature warning light
Off: working temperature too low
On: right working temperature
Blinking: excessive working temperature, carry out drainage ⓪ Main switch ☕ 1 or 2 cups of regular coffee ☕ 1 or 2 cups of espresso coffee ☕ 1 or 2 cups of tall coffee ☕ Pre-ground coffee selection button ☕ Heating plate selection button ☕ Steam selection button |
|--|--|

Unpacking/Installation

Standard packing is strong enough to protect the machine during mail shipping.

Keep this package to return the machine to the manufacturer, should it be necessary.

Before installing the machine, follow the following safety precautions:

-  Position the machine in a safe place.
-  Do not allow children to play with the machine
-  Make sure the machine is not placed nearby hot surfaces or open flames.

Whenever possible, always use the machine with the swivel (21).

Thus, when installing the machine, make sure to rest it directly on this support by inserting it into the slot on the lower side of the machine.

Now the machine is ready to be connected.

Power supply connection

-  Warning: electric current may cause death! Always keep to safety indications.

The coffee machine must be connected to an adequate socket.



Voltage must suit to the voltage specified on the appliance rating plate.

-  Never use defective power cords. Defective power cords and plugs must be replaced by authorised personnel.

-  Should an extension cord be used, check its perfect condition.

The extension cord must have a minimum section of 1 mm² and must be supplied with a three-pole plug/socket.

Starting and use

-   **Danger!**
Electric voltage may cause death. Electrical parts should never be in contact with water: danger of short-circuit. Overheated steam and hot water may cause burns!

Do not direct steam or water jet towards the body; furthermore, great attention must be given when touching either the dispensing tube or the heating plate: danger of burns!

For your own safety as well as for other people safety, keep to the safety precautions described (see pages 26/27).

-  Never use the machine without water and coffee beans.

Remove measuring spoon, brush and the central unit key from the coffee grounds container (1) and keep them within reach.

Unwind the power cord (24) from the rear side of the machine.

25 Coffee bean container (11) is attached with two screws.

Remove the cover (12) and fill it with coffee beans (approx. 300 g), then replace the cover. Adjust grinding by means of the grind adjustment lever (13), positioning it on point "5" of the scale.

 Never fill the coffee bean container with other products! (They might damage the machine!)

 Before filling the container with coffee beans, make sure the pre-ground coffee container is closed to prevent coffee grains from falling into it (they might damage the machine).

Remove the water tank (8) from the machine, remove its cover (9) and fill it with cold water (approx. 2.4 l).

A valve on the tank bottom prevents water from escaping.

Before installing the water tank in the machine, make sure the coffee bean container cover is properly fitted.

26 Install the water tank, slightly pressing over it to fit the valve which will open automatically. Replace the cover on the tank.

 Do not fill the tank with an excessive quantity of water.

 Always fill the tank with fresh water: hot water as well as other fluids might damage the tank.

 Do not switch on the machine if the water tank is empty: always make sure there is enough water in the tank!

Connect the plug to the socket and press the main switch.

When the switch is turned on (green colour), the electronic circuit carries out a self-diagnosis. This phase could make some noise.

Drainage

Direct the steam/hot water dispensing tube (5) over the drip tray (2).

Place a cup or another suitable container under the dispensing tube, then turn the steam/hot water selection knob (6) counterclockwise.

The pump automatically starts.

Wait until a regular water jet is obtained, then close the knob. The machine is now drained.



Important: It is advisable to drain the machine before the first start, after a prolonged use or whenever the water tank has been completely emptied.

Furthermore, should temperature  or water tank  warning lights blink, drain the machine.

The machine is ready for use as soon as the temperature light is on.

Programming the machine

27 To enter the programming mode, turn the machine off with the main switch.

Press steam , espresso coffee  and the main switch at the same time.

Release the buttons.

Water hardness adjustment

In order to adjust the water hardness, it is necessary to test the water using the strip supplied with the machine.

Dip the strip into the water for a second, shake off excess water gently, wait approx. 1 minute and read the result.

The tall coffee button  allows a water hardness adjustment from 1 to 4.

Each time the key is pressed, the value increases by 1.

As soon as value 4 has been reached, the counter resets and restarts from 1.

As far as lime scale values are concerned, see page 37, points 45-48.

Pre-Grinding

The coffee grinder is activated by pressing the button of the heating plate .

When this button lights up, the coffee grinder has been activated.

Grinding occurs every time the doser is empty, thus a ground coffee portion is always ready in the doser, saving time.

Pre-Infusion

The regular coffee button  activates or deactivates the dispensing of coffee, as shown by the lit button.

As soon as the coffee has been moistened, the pump stops for two seconds. Then the brewing cycle continues.

Coffe dosage adjustment

28 Adjustment lever (19) allows the selection of the coffee quantity, from 6 to 9 grams.

Open the service door (15) and place the adjustment lever (19) in the desired position.

Note: Opening the service door causes the machine to stop automatically. Close the door to restart the machine.



Coffee dosage must not be changed frequently, otherwise the coffee dis-

penser may get damaged, thus spoiling the quality of coffee.

Recommendations

Test

If the machine has not been used for a prolonged period, it is advisable for hygienic reasons to run a rinse cycle through the machine.

Place a cup under the dispensing tube (5) and operate the steam/hot water knob (6). Fill a cup with water.

Preheating cups

Cups may be preheated by placing them on the heating plate.

Temperature warning light

When connecting the machine, the green warning light will light permanently after approx. two minutes, showing the machine is ready to be used.

Empty coffee bean container warning light

When this led is on, the coffee grinder stops. Fill the container with coffee bean and restart the cycle.

Empty water tank warning light

An empty water tank causes the cycle to stop automatically.

Fill the tank with water. It is of the utmost importance to drain the circuit before restarting the machine.

It is not possible to start programming without carrying out the drainage.

When restarting the machine, make sure the red warning light is not blinking or is off.

Grind

If the coffee flows too quickly (coarse grind) or too slowly (fine grind) into the cup, adjust the coffee grinder.

Recommended grind level: position 5

Grind too coarse= adjust to a lower value (from 5 to 3)

Grind too fine= adjust to a higher value (from 5 to 7).



Adjust the grind level only when the coffee grinder is running.

Avoid extreme adjustment (for instance, on position 1) whenever possible.

It is preferable to try another coffee blend, because not all coffee blends are suitable.

Coffee

Make sure coffee is fresh.

An espresso roast is preferable in order to obtain a strong and aromatic espresso coffee, use special blends suitable for espresso coffee machines and special cups with thick sides.

Keep coffee in a cool place, in a hermetically sealed container.

Coffee may be deep frozen and then ground either fresh or frozen.

Water quality

In addition to blend, grind and water temperature, the water quality is of the utmost importance for the brewing of a good coffee.

Thus, the use of a decalcifier to remove limescale and eliminate any unpleasant taste and organic impurities from the water, is strongly recommended.

Furthermore, a decalcifier partially eliminates limescale from water, thus protecting the machine heating system from chemical buildup and prolonging its working life.

The water tank must be emptied daily and filled with fresh water.

Operation time

The machine may be kept on all day long. However, should the machine not be used for a prolonged period, it is advisable to turn it off. Once switched on, it will be ready for use within two minutes.

Switching off the machine



Switch the machine off only after the coffee cycle has been concluded.

Brewing

Cup level adjustment

This machine allows the precise dosage of the coffee quantity, according to the cup dimension.

The cup levels have been pre-set at the factory according to the following values:

 espresso coffee:	60 ml
 regular coffee:	125 ml
 tall coffee:	max. 250 ml.

Cup level setting

Ex. espresso coffee.

When the machine is ready, press and keep pressed the espresso coffee button  and wait until the desired quantity of coffee has flown into the cup.

Upon releasing the button, the level is automatically saved, thus always allowing to obtain the same quantity of coffee.

Use the above mentioned procedure also to change or adjust the quantity of water either for regular or tall coffee.

The quantity for two cups of coffee will be automatically adjusted according to the single cup level.

Double quantity of coffee or 2 cups of coffee.

By pressing the desired selection button twice, the machine will brew a double quantity of coffee.

Bean coffee

29 This machine grinds a portion of fresh coffee for each cup; for two cups, it grinds two portions of coffee, one after the other, thus ensuring optimum coffee quality.



Before any use, make sure the steam/hot water knob is closed.

Adjust the desired grinding degree: the recommended average value is 5.



The grinding degree must be adjusted only when the coffee grinder is operating, otherwise it may be damaged.

Place one or two preheated cups on the grill (3) under the dispenser (4).

By pressing the relevant selection button the machine will automatically dispense the selected coffee.

The coffee flow can be stopped at any moment by pressing any selection button (except those relevant to the heating plate and steam).

This operation can be performed, for instance, if an excessive quantity of water has been selected.

Pre-ground coffee



Make sure to use pre-ground coffee only (medium ground).

Never use whole bean or soluble coffee!



Right before making coffee, fill the container with freshly ground coffee.

Use the quantity necessary for the number of cups to be obtained.

Always remember that ground coffee ages soon, thus losing its quality.

30 Use the measuring spoon supplied to fill the container with ground coffee (14).
Use a full measure only!



Do not tamp ground coffee, otherwise the optimum dosage for each cup is no longer ensured.

Then, press the pre-ground coffee selection button  and the desired selection button (espresso, regular or tall coffee) to obtain a cup of coffee.

The coffee flow may be stopped at any moment by pressing any selection button (except those of the heating plate and steam), if, for instance, an excessive quantity of water has been selected.

Hot water

The hot water dispensing is separate from the coffee circuit, in order to supply hot water for tea, soup etc.

31 Place the glass or the cup under the steam/hot water dispenser (5), then slowly open knob (6), turning it counterclockwise. Hot water will be automatically dispensed. As soon as dispensing is over, close knob again.

Steam

To heat milk or other drinks.



Clean the spout with a damp cloth soon after use; otherwise it might be difficult to remove milk residues.



After a steam outflow, always drain the machine, otherwise the coffee brewing program automatically stops, due to excessive temperature.



If the machine is on the steam mode, the automatic coffee brewing is prevented.

Press the steam selection button  and wait until the green temperature warning light  turns on.

Direct the steam/hot water dispenser (5) over the cup holder grill (3) and slightly open knob (6), turning it counterclockwise.

Wait until the remaining water has flown out of the spout.

Then move the spout outwards and immerse it into the fluid to heat.

32 Slowly open the steam/hot water knob and heat the fluid, using a circular movement from bottom to top.

When the fluid has reached the desired temperature, close the knob and immediately clean the spout with a damp cloth.

Warning: the spout is hot, it may cause burns!

As soon as the steam/hot water dispensing is finished, position the steam/hot water dispensing tube over the cup holder grill and deactivate the steam function by pressing the steam selection  button.

Then open the steam/hot water knob again and drain the machine (the pump automatically starts) until the water flows regularly from the dispensing tube (see the chapter relevant to Drainage, page 30) and the temperature warning light stops blinking.

Close the steam/hot water knob.

The machine is ready to brew coffee again.

Cappuccino froth

Fill a cup 1/3 with cold fresh milk, then immerse the steam/hot water dispensing tube (5) just below the milk surface.

Move the cup with a circular movement to form a thick froth. Then immerse the dispensing tube deep into the milk to heat it.

Incorporated safety devices

Automatic off

Should the service door be open, the machine automatically switches off and its operation is thus prevented.

If the central unit is not mounted, only water and steam can be dispensed.

Electronic grinding time control

As soon as the coffee bean container is empty, the machine automatically stops after approx. 20 seconds.

Fill the container with coffee bean. The coffee brewing cycle can be restarted.

Electronic pump control

The machine switches off automatically as soon as the water tank is empty.

Automatic temperature adjustment

This adjustment controls the correct temperature to brew coffee and to dispense hot water and steam.

Coffee brewing is automatically interrupted should the water temperature be too low or too high (safety thermostat and overheating safety device activated).

Antigravel device

Even selected coffees may contain some impurities.

The coffee grinder is fitted with an antigravel device to avoid any damage.

Should gravel end up into the coffee grinder, you will hear a strong and characteristic noise. Stop the machine immediately, otherwise the protection system will stop the coffee grinder after approx. 20 seconds.

Important: Do not start the machine until the matter has been removed, otherwise the motor may be damaged.

Procedures: see page 36, points 38-42.

Cleaning/Maintenance

Cleaning

To ensure high coffee quality and a longer working life of the machine, always keep the machine clean.



Before cleaning the machine, turn off the main switch and unplug the machine.



Before cleaning the machine, wait until it cools down.



Do not immerse the machine into water or other fluids (it may be damaged).



Do not wash parts of the machine in the dishwasher.



Always handdry all parts of the machine; do not dry them in the oven or microwave oven!

Water tank/ Drip tray/Coffee grounds container/Coffee dispensing unit/Coffee machine

33 In order to keep the dispensing area and the central unit (16) clean, it is recommended to empty the coffee grounds container (1) every day.

The water tank (8), drip tray (2), cup holder grill (3) and coffee grounds container should be washed periodically, using a non-abrasive solvent and drying them carefully.

34 The coffee dispenser (4) may be removed for cleaning operations.

Unloose the the screws and rinse the dispensing tubes thoroughly with hot water.

From time to time, clean the machine casing with a damp cloth and dry it.

Clean the pre-ground coffee container (14) with the aid of the brush supplied, whenever necessary.

Central unit

Clean the central unit (16) whenever the coffee bean container has been refilled, or at least once or twice a week.

Switch off the machine by pressing the main switch and open the service door (15). Remove the coffee grounds container (1).

35 Remove the central unit (16) by holding it by the handle and pressing the "PRESS" key.

Wash the central unit with hot water.

Make sure there are no coffee residues on the two chrome-steel filters.

Dry it thoroughly.

36 Remove the coffee rest drawer (20) and clean it, using a non-abrasive soap.

Clean the service area thoroughly with a damp cloth and re-insert the coffee grounds container again.

37 By holding the central unit by its handle, slide it back into its original position, making sure it is correctly engaged. Then close the service door. Insert the coffee grounds container again.



When replacing the central unit, do not press the "PRESS" key (it may cause damages to the machine)!

Warning: if the central unit is not correctly inserted, the warning light  switches on, thus preventing the machine from brewing coffee.

Coffee grinder



Never fill the coffee grinder with water: it may damage the machine!

38 Should coffee grains stick together in the container, the latter must be cleaned; unplug the machine before carrying out this operation. Empty the coffee container and loosen the two screws. The container can now be removed and cleaned.

39 Carefully pull the adjustment lever upwards.

40 Turn the adjustment ring towards the left to make the blue marks coincide.

41 Now remove the grind ring from the machine, pulling it slightly upwards.

42 With the aid of a brush or a narrow vacuum hose, clean both the coffee grinder box and the

grind ring support.

Make sure the position of the grind ring does not shift.

To re-assemble the coffee grinder, carry out the reverse sequence, making sure the adjustment ring has not been shifted during cleaning.

If that is the case, turn the adjustment ring to make the blue mark coincide with one of the three notches.

Assemble the grind ring support and make sure the blue marks coincide.

43 Turn the adjustment ring clockwise to make the red marks coincide.

44 Fit the adjustment lever on the ring, making sure the grind level is on position 6.

Descaling

Descaling is necessary to remove limescale from surfaces and holes, thus ensuring a perfect operation of valves, heating controls and other important parts.

According to water hardness, the machine must be descaled every 3-4 months, according to the water hardness degree.

A more frequent descaling is recommended wherever the water hardness degree is very high.

This machine is supplied with a particular warning light  to make this operation easier.

Descaling must be carried out at the latest when this warning light switches on.

Furthermore, said warning light may be adjusted according to the water hardness degree.

The machine has been adjusted at the factory to a 25°fH value, which causes the warning light  to switch on after approx. 150l.

The water hardness value may be changed, if

necessary, following the instructions shown on page 30.

The following adjustments are possible:

45 Hardness index 1: high water hardness, exceeding 29°fH (14°dH), approx. 80 l water passage.

46 Hardness index 2: medium water hardness, approx. 20-29°fH (7-14°dH), approx. 150 l water passage.

47 Hardness index 3: soft water, approx. 12-20°fH (47°dH) approx. 300 l water passage.

48 Hardness index 4: very soft water, less than 10°fH (3°dH), more than 500 l of water passage.

In case of hard water, a filter should be used both to improve the coffee quality and to protect the machine, thus reducing the descaling frequency.

Descaling must be carried out as follows:

Note: for this purpose, use a descaling product suitable for coffee machines.

Never use vinegar to clean the machine; it might damage it.

There are two ways to carry out the descaling of the machine:

Automatic descaling

Turn the machine off.

Pour descaling solution into the water tank (according to the instructions on the descaling solution package).

Switch the machine on to the programming mode (see page 30, point 27).

Place a large container under the steam/hot water dispensing tube (5) and open the steam/hot water knob (6) slowly.

The contents of the tank are pumped quickly through the machine, saving time.

Standard descaling

Switch off the machine.

Pour a descaling product into the water tank (according to the instructions on the descaling solution package).

Switch the machine on to the programming mode. Place a large container under the steam/hot water dispensing tube (5) and open the steam/hot water knob (6) slowly, turning it counterclockwise.

Turn on the machine by pressing the main switch (31) and let the descaling product flow out of the dispensing tube for approx. 1 min.

Close the knob again.

Turn off the machine with the main switch and let the solution take effect for approx. 5 minutes. Repeat this procedure two or three times, to allow all of the descaling product in the water tank to flow out of the dispensing tube.

As soon as descaling has been carried out, rinse the tank (8) thoroughly and fill it with fresh water. Switch on the machine and let fresh water (approx. 2 l) flow out of the steam/hot water dispensing tube in order to rinse away residue.

The machine is now ready for operation.

When the machine is on, the  warning light switches off automatically, by pressing the steam selection button for at least 5 seconds.

Important

A periodic descaling avoids expensive repairs. The machine warranty does not cover damages occurring as a result of the non-observance of descaling procedures, improper use and failure to comply with and follow any other instructions contained herein.

Maintain the manufacturer's adjustment if the water hardness degree is not known.

Storage of the machine

 Switch off the machine and unplug it if the machine will not be used for long periods of time.

 Keep the machine in a dry place, far from the reach of children.

Should the machine not be used for a long period, protect it from dust and dirt.

Maintenance

Periodically check the machine and clean it in accordance to the instructions.

Disposal

Machines which are no longer operational should immediately be made non-serviceable, by cutting the power cord. Machines should be delivered to a public disposal centre.

Troubleshooting

 In case of failure, fault or suspected damage following a fall, unplug the machine immediately.

To fix problems, follow the instructions in the table below. Otherwise contact an authorised technician.

Only skilled personnel are authorised to service and repair the machine.

The user might incur serious injuries should repairs not be properly carried out.

The manufacturer declines any liability whatsoever, should repairs fail to be carried out according to the instructions contained in this manual. Furthermore in these cases, warranty rights cannot be honored.

Problem	Possible cause/causes	Resolution
The main switch does not turn on	The machine is not getting power The service door is open	Check plug and fuse Close the service door
The automatic coffee brewing does not start	The  warning light is on: the central unit is not correctly inserted or incorrectly positioned. The  steam selection button is on.	Insert or position the central unit Deactivate the function and drain the machine (see page 30)
	Empty tank or coffee bean container warning lights are on	Fill with water or coffee bean and switch the machine off and then on again to start the cycle
	Temperature warning light is on: following a steam outflow, the machine has not been properly drained	Drain thoroughly the machine again.
	Coffee grounds warning light is on: the container is full or not properly inserted	Empty the coffee grounds container and insert it properly
	Bean coffee warning light blinking: the coffee grinder is jammed	Clean the coffee grinder (see page 36)
Water is dispensed instead of coffee	Pre-ground coffee selection button has been pressed, but the pre-ground container is empty	Fill with pre-ground coffee
Steam and/or hot water are not dispensed	The steam/hot water spout hole is clogged	Clear it with the aid of a thin needle
Coffee flows too quickly	Grind is too coarse	Adjust the grinder to a finer grind, ex. from 6 to 3
Coffee flows too slowly	Grind is too fine	Adjust the grinder to a coarser grind, ex. from 6 to 7
Coffee is not hot enough	The cup has not been preheated The temperature warning light is not yet on	Place the cup on the heating plate before dispensing coffee into it Wait until the temperature warning light switches on permanently
Coffee not creamy	The coffee blend is not suitable, coffee has not been recently ground, the pre-ground coffee has been ground too thin or too coarse	Try another coffee blend
The coffee brewing is reduced; the machine takes longer to heat and the water capacity is not correct	Limescale in the machine	Carry out descaling of the machine, as described on page 36
The central unit cannot be removed	The central unit is out of position	Switch on the machine. Close the service door. The machine returns automatically to its starting position.